

TUNING TIPS

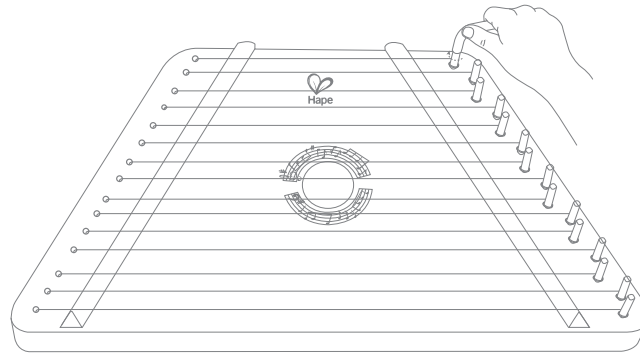

E0323

Just like the classical guitar, the string is made of Nylon. Nylon is much safer than metal string. However, like all professional instruments, your harp may need to be tuned after you take it home and will also need to be re-tuned periodically.

There are many tuning instruments that can be used to tune your harp. You can use a pitch pipe, tuning fork, piano, electronic keyboard or any other musical instrument that is already properly tuned. You can also download tuning software to your cellphone.

To tune, choose a key that you would like to use. Then match the sound from the key to the sound of the longest string on the harp. Once you have the first string tuned, adjust the other strings sequentially going up the scale (do, re, mi, etc.).

After tuning all the strings in the correct scale, insert a music sheet and play a song that you are familiar with (we suggest "Twinkle, Twinkle, Little Star").

If the song sounds correct, then you have successfully tuned the harp. If it doesn't sound correct or you can't tell the difference, we recommend that you have the harp tuned by a friend or professional (local music store or music teacher) who is familiar with music.

HOW TO RE-STRING YOUR HAPPY HARP

Replacing strings should only be done by an adult. If you are unsure of the following task, please seek assistance from your local music store or a music teacher. You will need a set of pliers and wire cutters. We also recommend that you wear safety goggles.

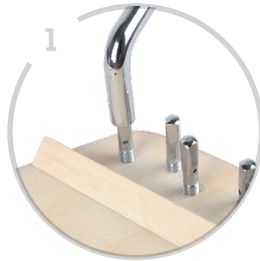

1
Loosen the pins with approximately five complete turns each.

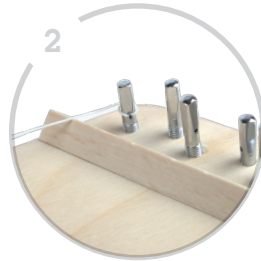

2
Thread the string through the hole in the tuning pin. Bend the string after inserting it through the tuning pin to keep it in place.

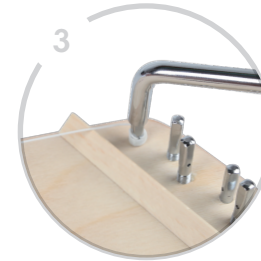

3
Tighten the tuning pin approximately five complete turns. Be sure that the string is being wound below the hole in the turning pin.

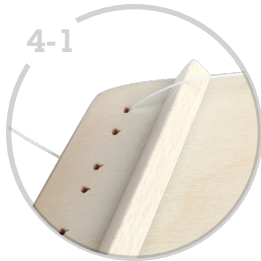

4-1
After the first tuning pin is threaded, thread the string through the parallel hole on the left side of the harp, bringing the string up through the hole directly underneath. Finish the 2nd row by threading the 2nd tuning pin from the top on the right side. Continue with threading the rows of strings in the same manner for any others that need replacing. (Please note that this step is not necessary on the bottom string as it has only one tuning pin and hole.)

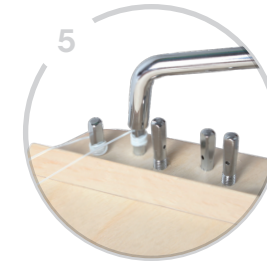
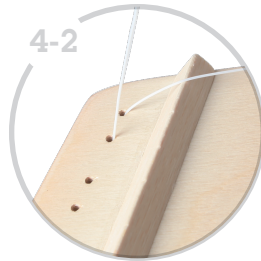

5
Repeat steps 2 and 3 to tighten another pin.

Use wire cutters to remove excess string and carefully bend the end of the string downward to protect players from the tip of the wire. Use the Happy Harp Tuning Tips regularly to fine tune your instrument.



Happy Harp

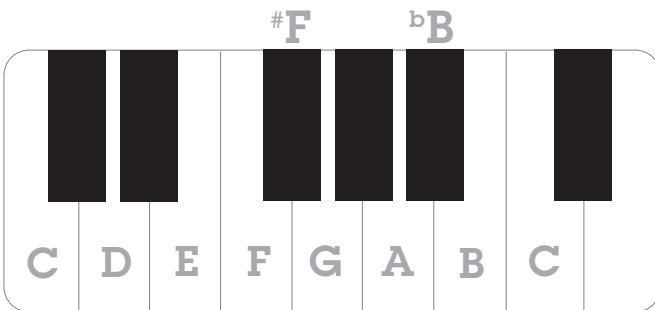

G Do 1		1 Do F
#F Ti 7		7 Ti E
E La 6		6 La D
D So 5		5 So C
C Fa 4		4 Fa bB
B Mi 3		3 Mi A
A Re 2		2 Re G
G Do 1		1 Do F
#F Ti 7		7 Ti E
E La 6		6 La D
D So 5		5 So C
C Fa 4		4 Fa bB
B Mi 3		3 Mi A
A Re 2		2 Re G
G Do 1		1 Do F

So-fa syllables

Numbered musical notion

Pitch name

KEY OF "C"

KEY OF "D"

KEY OF "E"

KEY OF "F"

KEY OF "G"

Do	Re	Mi	Fa	So	La	Ti														
1	2	3	4	5	6	7														
C	D	E	F	G	A	B														
D	E	#F	G	A	B	#C														
E	#F	#G	A	B	#C	#D														
F	G	A	bB	C	D	E														
G	A	B	C	D	E	#F														

LEARNING TO PLAY THE HAPPY HARP

Playing the Happy Harp is an ideal parent-child activity introducing children to music basics and enabling them to make music on their own. In addition, the Happy Harp is a great tool for children of all ages for developing coordination and fine motor skills.

Help your child learn to play using these activities and exercises:

- The songs included with Happy Harp range in difficulty. Pick one or two of the easier songs that your child is familiar with and sing the song together introducing the musical scale.
- Pluck the strings of the Happy Harp, starting from the bottom string up, and have your child do the same. This is to help them learn the difference between the notes.
- Starting with the same songs that you sang together, place a music sheet under the strings of the Happy Harp and play the first phrase of the song. For example, if you sang "Twinkle, Twinkle, Little Star", follow the notes on the music sheet to play "Twinkle, Twinkle, Little Star". Then have your child do the same.
- Play the entire song through to the end, emphasizing the idea of plucking the string above each note to create the song and then let your child play the whole song.
- Help your child understand that it may not sound perfect at first, but that with a little practice, the Happy Harp can make any child sound like a master musician!

Happy Harp

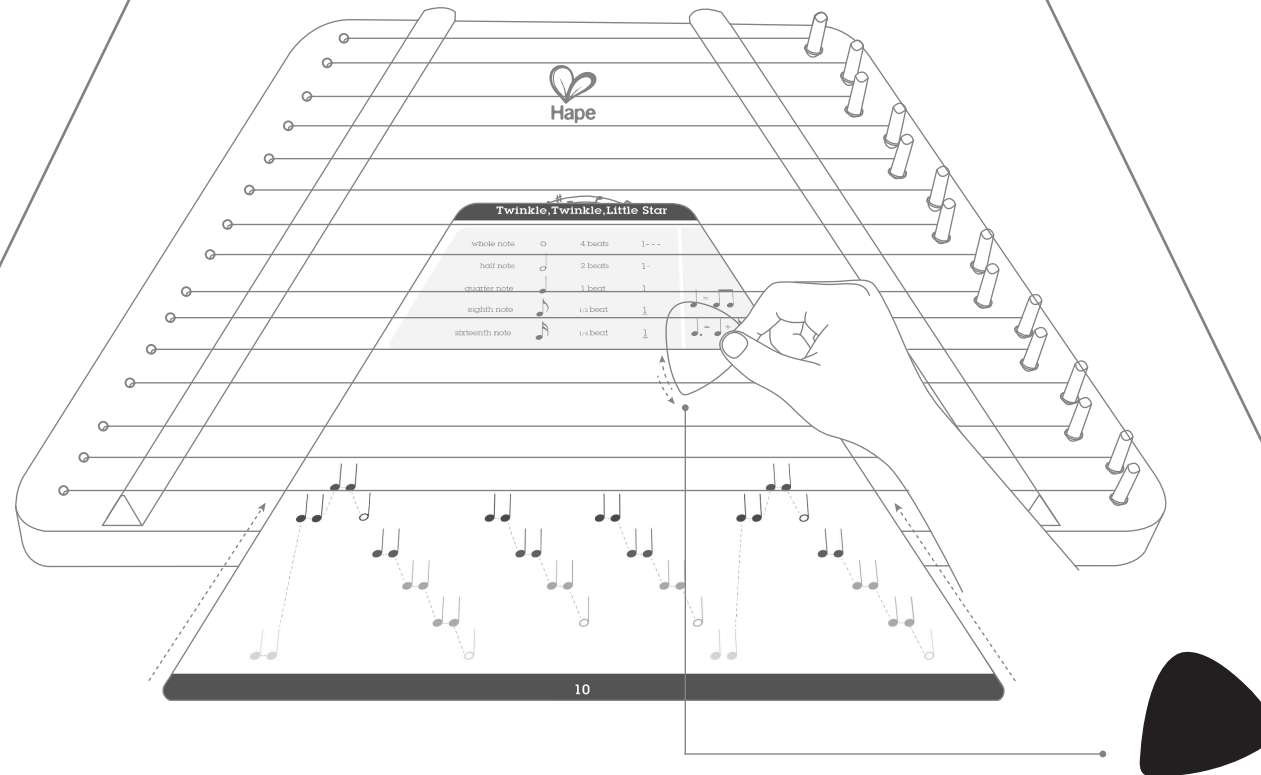

- Select a song among the eight Song Sheets included and insert it under the strings and on top of the harp.
 - Make sure the trapezoid-shaped Song Sheet fits perfectly onto the wooden platform. The strings will be parallel to the notes on the sheet.
- Play the music with the pick included from left to right according to the colored notes. Each note stands for picking the corresponding string.
 - Play lightly for a melodic tone with either left or right hand.
 - Move up or down to the other strings to create a harmonic song.
 - Practice the rhythm until you make a perfect song.
 - Perform for your parents to share your wonderful skills.

Mary Had a Little Lamb

whole note	○	4 beats	1 - - -
half note	◐	2 beats	1 -
quarter note	◑	1 beat	1
eighth note	◒	1/2 beat	<u>1</u>
sixteenth note	◓	1/4 beat	<u><u>1</u></u>

◑ = ◒ ◒

◑. = ◑ + ◒



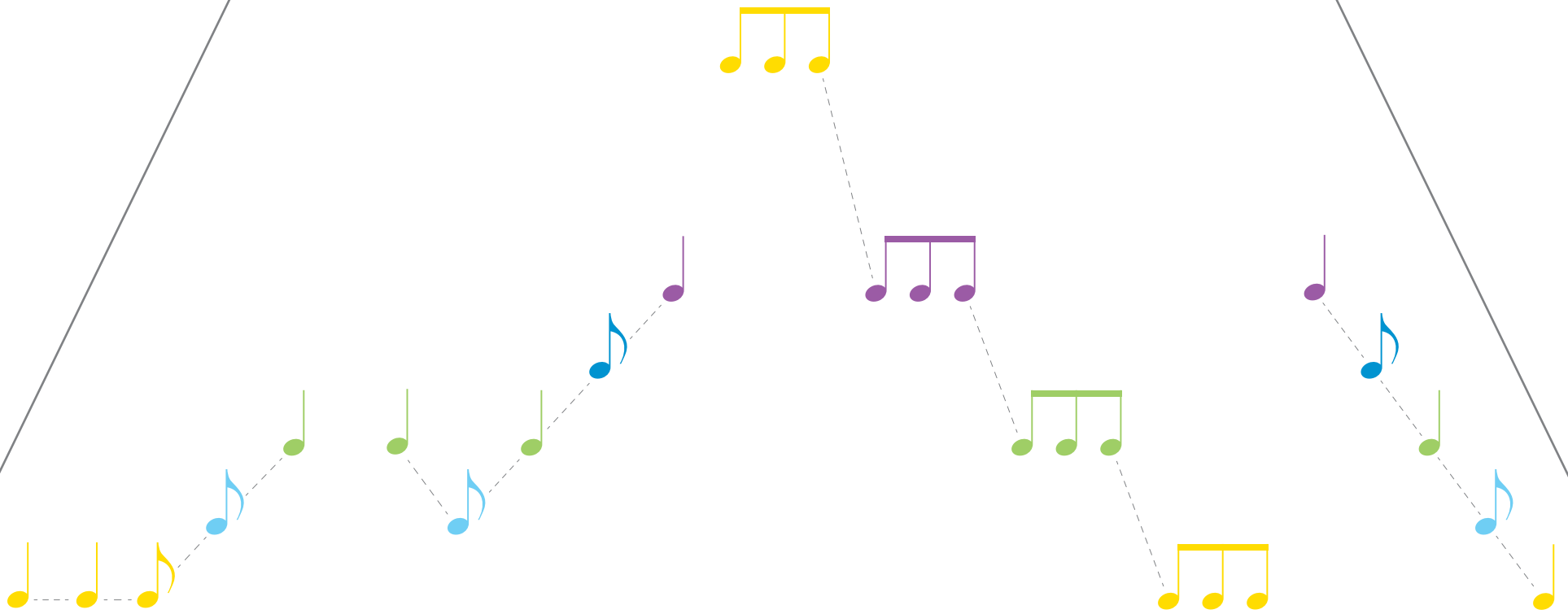
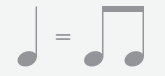

The image shows a musical score for the song 'Mary Had a Little Lamb'. The notes are color-coded: yellow for the lowest pitch, blue for a slightly higher pitch, green for a higher pitch, and purple for the highest pitch. Dashed lines connect the notes to show the pitch contour. The melody consists of several phrases: a descending line (yellow, blue, yellow), an ascending line (yellow, blue, green), a quarter note (green), a half note (green), a quarter note (blue), a quarter note (blue), a quarter note (blue), a quarter note (green), a quarter note (green), a quarter note (green), a quarter note (green), a quarter note (green), a quarter note (green), a quarter note (blue), a quarter note (blue), a quarter note (blue), a quarter note (yellow), a quarter note (yellow), a quarter note (blue), a quarter note (blue), a quarter note (blue), a quarter note (yellow).

Row, Row, Row Your Boat

whole note	○	4 beats	1 - - -
half note	○	2 beats	1 -
quarter note	●	1 beat	1
eighth note	●	1/2 beat	<u>1</u>
sixteenth note	●	1/4 beat	<u>1</u>



London Bridge Is Falling Down

whole note	○	4 beats	1 - - -
half note		2 beats	1 -
quarter note		1 beat	1
eighth note		1/2 beat	<u>1</u>
sixteenth note		1/4 beat	<u><u>1</u></u>

 = 

 =  + 

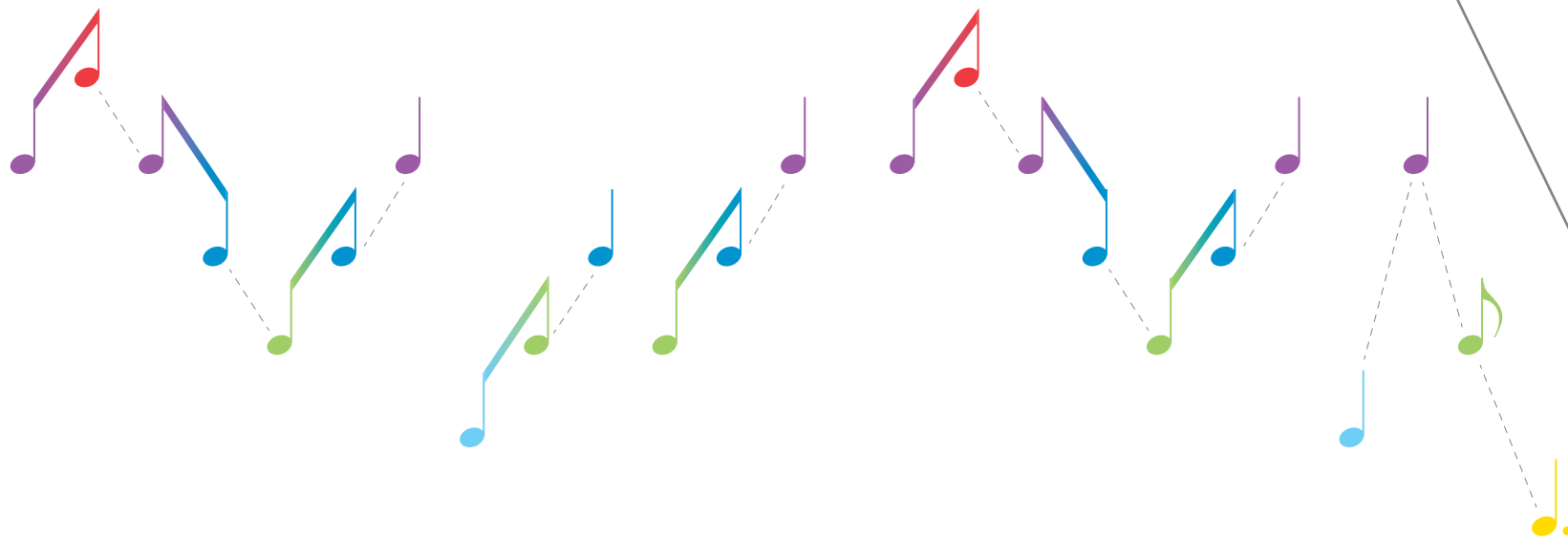



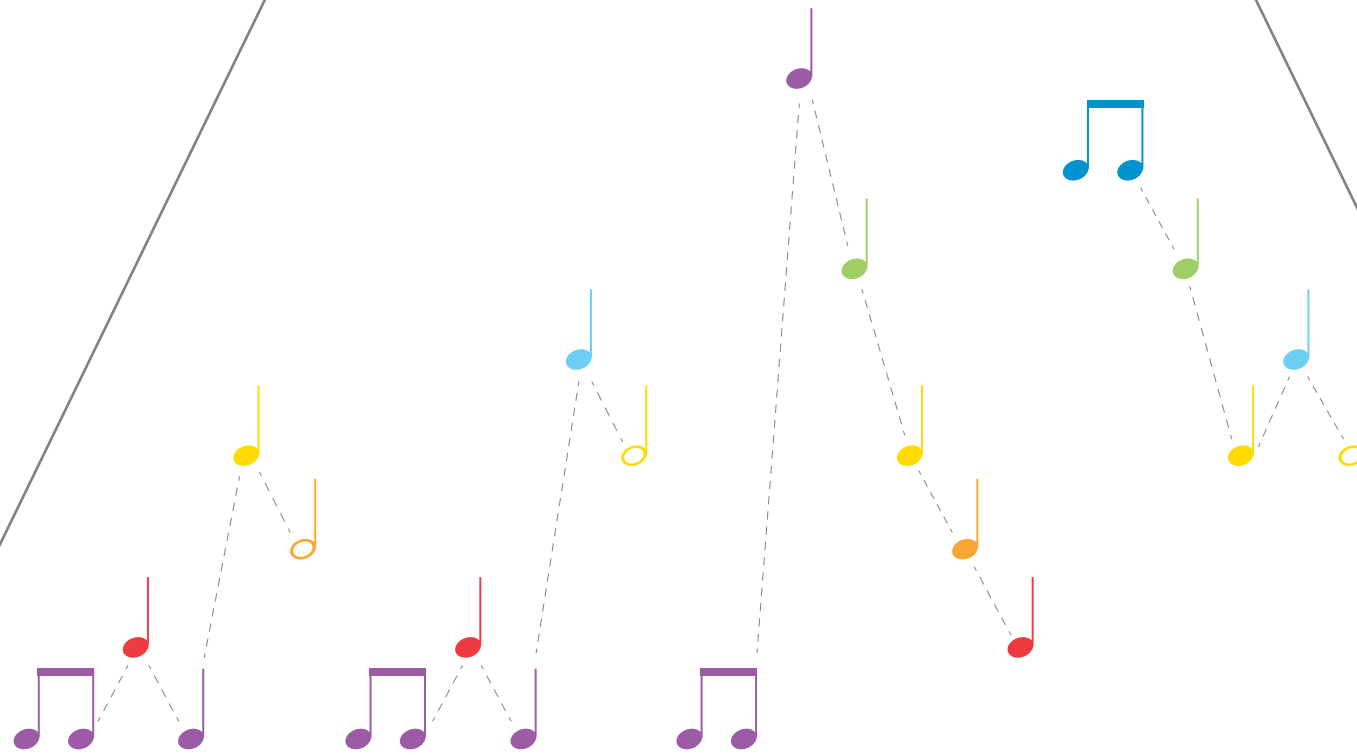

Happy Birthday to You



whole note		4 beats	1 - - -
half note		2 beats	1 -
quarter note		1 beat	1
eighth note		1/2 beat	<u>1</u>
sixteenth note		1/4 beat	<u>1</u>

Two examples of musical notation showing equivalence:
1. A quarter note is equal to two eighth notes.
2. A dotted quarter note is equal to a quarter note plus an eighth note.

Twinkle, Twinkle, Little Star

whole note		4 beats	1 - - -
half note		2 beats	1 -
quarter note		1 beat	1
eighth note		1/2 beat	<u>1</u>
sixteenth note		1/4 beat	<u><u>1</u></u>

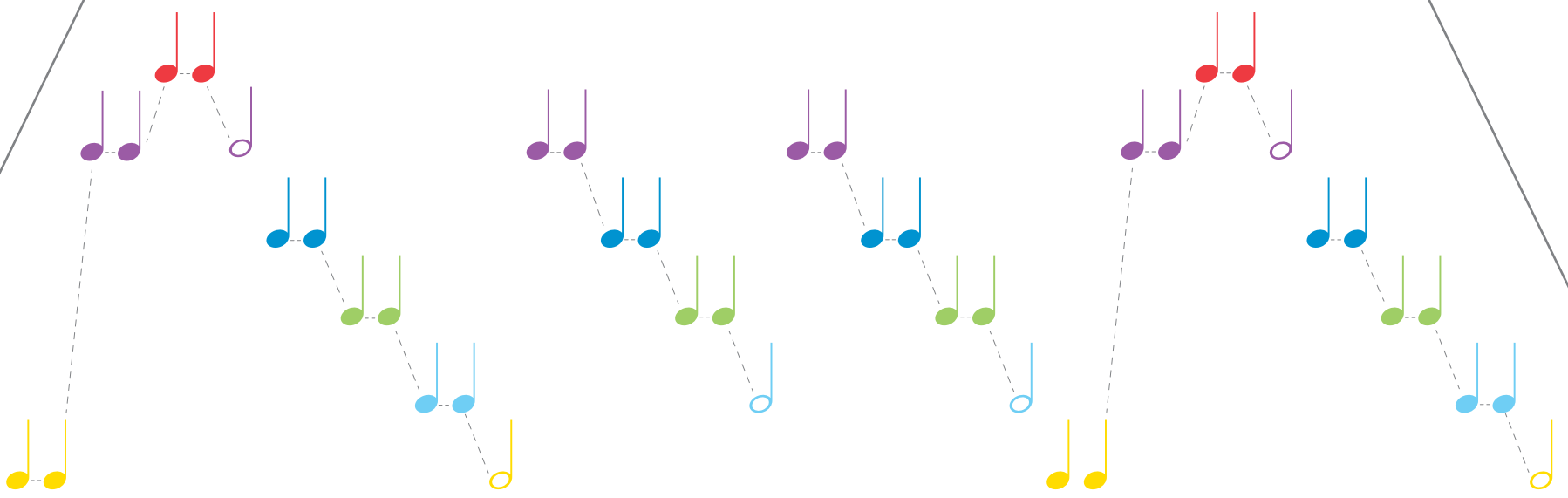

1
2
3
4
5
6
7
i

Do
Ti
La
So
Fa
Mi
Re
Do
Ti
La
So
Fa
Mi
Re
Do

TIPPS ZUM STIMMEN

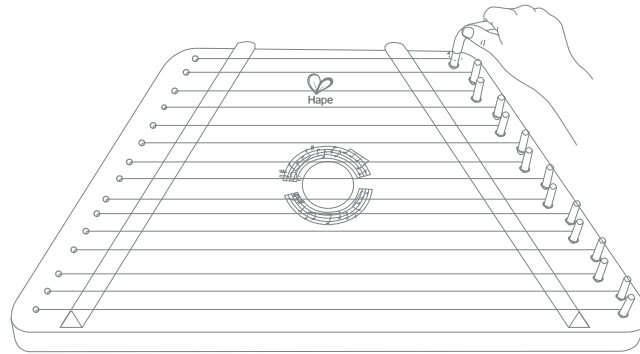

E0323

Die Saiten der Happy-Harfe sind wie bei einer klassischen Gitarre aus Nylon. Alle Saiteninstrumente müssen von Zeit zu Zeit nachgestimmt werden. So auch Ihre Harfe.

Um Ihre Harfe zu stimmen, können Sie eine Stimmpeife oder eine Stimmgabel verwenden. Ebenso geeignet sind ein gestimmtes Klavier, ein Keyboard und jedes andere Musikinstrument, das bereits richtig gestimmt ist. Es gibt zudem die Möglichkeit, Stimmsoftware auf Ihrem Handy zu installieren.

Die Happy-Harfe hat 15 Saiten. Sie kann grundsätzlich in jeder Tonart gestimmt werden (C-Dur, D-Dur, E-Dur, F-Dur, G-Dur). Die Tonreihenfolge umfasst immer 2 Oktaven. Wenn Sie die Harfe zum Beispiel in C-Dur stimmen wollen, wählen Sie zum Stimmen der tiefsten Saite ein C auf Klavier, Keyboard oder Gitarre und drehen Sie den dem Wirbel der Harfe so lange, bis die Töne identisch sind. Wiederholen Sie das bei allen folgenden Saiten mit den tonartgerechten Tönen der Tabelle. Bitte beachten: Das B entspricht dem deutschen H. Und das Bb dem deutschen B.

Wenn Sie alle Saiten als Tonleiter über zwei Oktaven gestimmt haben, legen Sie ein Notenblatt ein. Wählen Sie am besten ein Lied, das Sie gut kennen (wir empfehlen einfache Lieder wie „Twinkle, Twinkle, Little Star“).

Hört sich das Lied richtig an? Dann stimmt Ihre Harfe. Falls das Lied falsch klingt oder Ihnen das Stimmen schwerfällt, lassen Sie sich von einem Freund, Musiklehrer oder von einem Musikfachgeschäft helfen.

NEUE SAITEN AUFZIEHEN

Das Auswechseln von Saiten sollte nur ein Erwachsener durchführen. Wenn Sie unsicher sind, lassen Sie sich bitte von einem Musikfachmann helfen. Sie benötigen eine Zange und einen Seitenschneider. Wir empfehlen Ihnen, eine Schutzbrille zu tragen.



Lösen Sie jeden der Wirbel mit jeweils etwa fünf vollständigen Umdrehungen und entfernen Sie die alten Saiten.

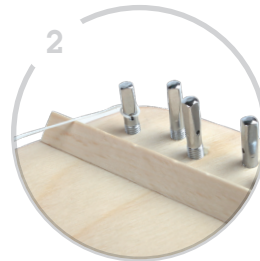

Fädeln Sie die neuen Saiten durch das Loch im Stimmwirbel. Biegen Sie anschließend den überstehenden Teil der Saite entgegen der Drehrichtung des Wirbels ab, um ihn zu fixieren.

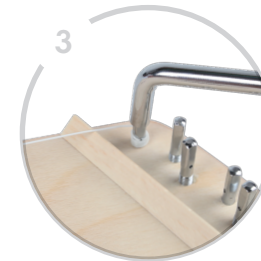

Ziehen Sie den Stimmwirbel mit ungefähr fünf Umdrehungen nach rechts an. Stellen Sie sicher, dass die Saite unter dem Loch im Stimmwirbel aufgewickelt wird.

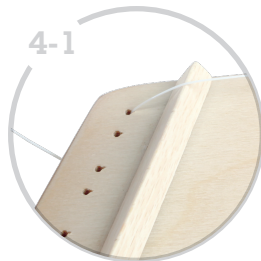

Fädeln Sie nach dem Umwickeln des ersten Stimmwirbels die Saite durch das linke Loch an der Harfe. Führen Sie die Saite durch das direkt darunter liegende Loch wieder nach vorne. Stellen Sie die zweite Reihe fertig, indem Sie die Saite auf den zweiten Stimmwirbel von oben rechts auffädeln.

Fahren Sie ebenso mit dem Auffädeln weiterer Seitenreihen fort, die ersetzt werden müssen. (Bitte beachten Sie, dass dieser Schritt für die unterste Saite nicht erforderlich ist, da sie nur einen Stimmwirbel und Stift hat).

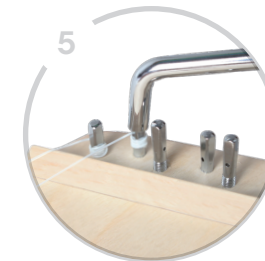
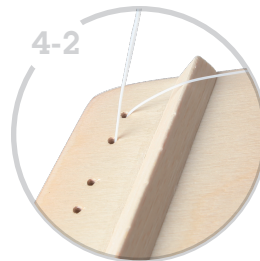

Wiederholen Sie Schritt 2 und 3, um einen weiteren Wirbel festzuziehen.

Entfernen Sie mithilfe des Seitenschneiders die am Wirbel überstehenden Saitenenden und biegen Sie das Ende der Saite vorsichtig nach unten, um den Spieler vor der Spitze des Drahtes zu schützen. Stimmen Sie das Instrument regelmäßig mithilfe der Tipps zum Stimmen der Happy-Harfe.



Happy Harp

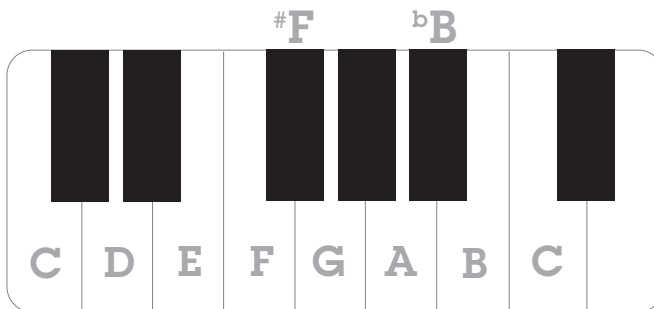

G Do 1	#F Ti 7	i Do F
E La 6	D So 5	7 Ti E
D So 5	C Fa 4	6 La D
C Fa 4	B Mi 3	5 So C
B Mi 3	A Re 2	4 Fa bB
A Re 2	G Do i	3 Mi A
G Do i	#F Ti 7	2 Re G
#F Ti 7	E La 6	i Do F
E La 6	D So 5	7 Ti E
D So 5	C Fa 4	6 La D
C Fa 4	B Mi 3	5 So C
B Mi 3	A Re 2	4 Fa bB
A Re 2	G Do 1	3 Mi A
G Do 1		2 Re G
		1 Do F

So-fa-Silben

Nummerierter musikalischer Begriff

Name der Tonlage „C“ TONART

„D“ TONART

„E“ TONART

„F“ TONART

„G“ TONART

Do	Re	Mi	Fa	So	La	Ti						
1	2	3	4	5	6	7						
C	D	E	F	G	A	B						
D	E	#F	G	A	B	#C						
E	#F	#G	A	B	#C	#D						
F	G	A	bB	C	D	E						
G	A	B	C	D	E	#F						

SO SPIELEN SIE DIE HAPPY-HARFE

Gemeinsam Happy-Harfe zu spielen, ist eine schöne Eltern-Kind-Aktivität. Denn Kinder werden so in die Grundlagen der Musik eingeführt und lernen, alleine Musik zu machen. Darüber hinaus ist die Happy-Harfe ein tolles Instrument für Kinder aller Altersstufen, um Koordination und Feinmotorik zu trainieren.

So gehen Sie konkret vor:

- Die mit der Happy-Harfe gelieferten Lieder haben unterschiedliche Schwierigkeitsgrade. Wählen Sie leichte Lieder, die Ihr Kind kennt. Erster Schritt: Singen Sie das Lied zusammen, um dabei die Melodie vorzustellen.
- Zweiter Schritt: Zupfen Sie die Saiten der Happy-Harfe von der untersten bis zur obersten. Lassen Sie Ihr Kind dasselbe tun. Auf diese Weise lernen Kinder die Unterschiede zwischen den Tönen kennen.
- Dritter Schritt: Ein Lied auf der Harfe spielen. Beginnen Sie einem einfachen Lied, das Ihr Kind kennt. Legen Sie das entsprechende Notenblatt unter die Saiten der Happy-Harfe und spielen Sie die erste Strophe des Liedes. Gehen Sie anfangs langsam vor. Dann ist Ihr Kind an der Reihe.
- Vierter Schritt: Spielen Sie das ganze Lied bis zum Ende und zeigen Sie dabei, wie die Saiten über jeder Note gezupft werden, um das Lied zu spielen. Lassen Sie dann Ihr Kind das ganze Lied spielen.
- Helfen Sie Ihrem Kind zu verstehen, dass noch kein Musikmeister vom Himmel gefallen. Deshalb kann es sein, dass am Anfang vielleicht noch nicht perfekt klingt. Aber mit ein wenig Übung kann jedes Kind die Happy-Harfe schnell schön klingen lassen!

Happy Harp

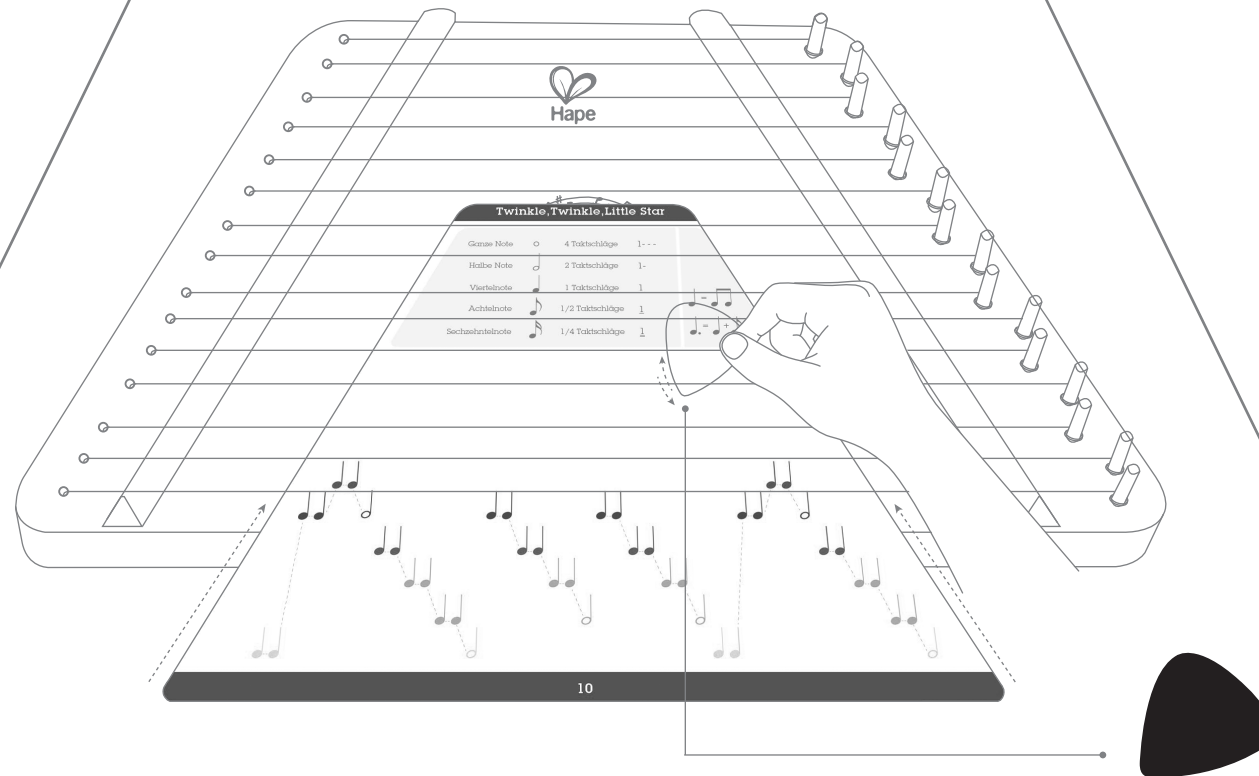

- Darauf achten, dass der trapezförmige Liederbogen genau auf die Holzplattform passt. Die Saiten sind parallel zu den Noten auf dem Bogen.
- Spiele die Musik mit dem beiliegenden Plektron von links nach rechts gemäß der bunten Noten. Jede Note steht für das Zupfen der entsprechenden Saite.
 - Wichtig: Das Plektron nur leicht über die Saiten führen.
 - Übe den Rhythmus, bis dein Lied perfekt klingt.
- Spiele deinen Eltern vor, um dein wunderbares Können zu zeigen.

Mary Had a Little Lamb

Ganze Note	○	4 Taktschläge	1 - - -
Halbe Note	◐	2 Taktschläge	1 -
Viertelnote	◑	1 Taktschläge	1
Achtelnote	◒	1/2 Taktschläge	<u>1</u>
Sechzehntelnote	◓	1/4 Taktschläge	<u><u>1</u></u>

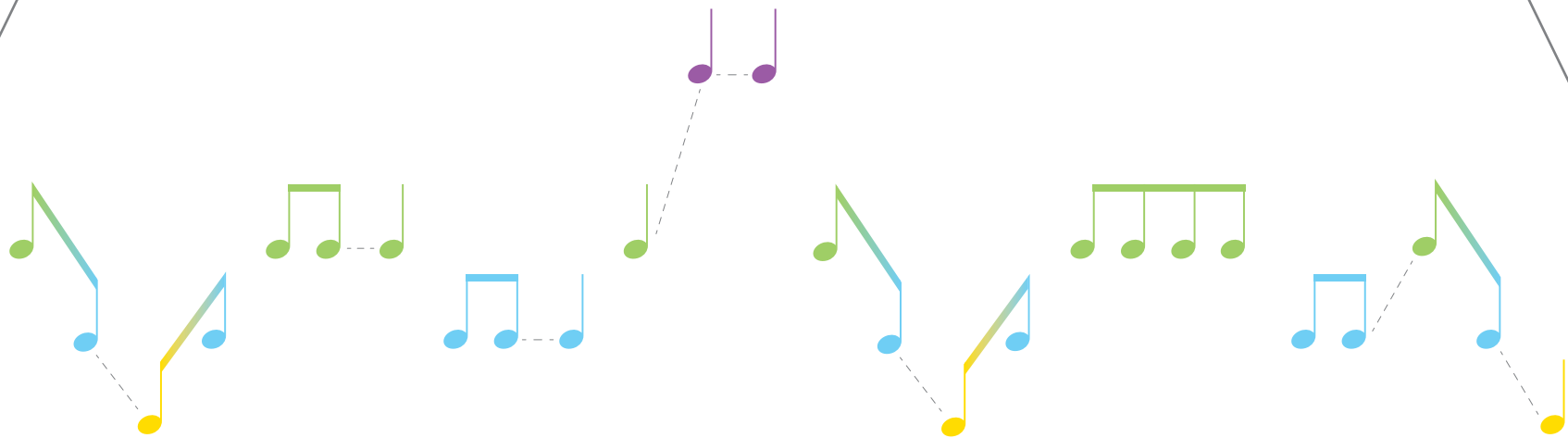
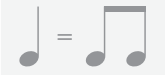

Row, Row, Row Your Boat

Ganze Note	○	4 Taktschläge	1 - - -
Halbe Note	◐	2 Taktschläge	1 -
Viertelnote	◑	1 Taktschläge	1
Achtelnote	◒	1/2 Taktschläge	<u>1</u>
Sechzehntelnote	◓	1/4 Taktschläge	<u><u>1</u></u>

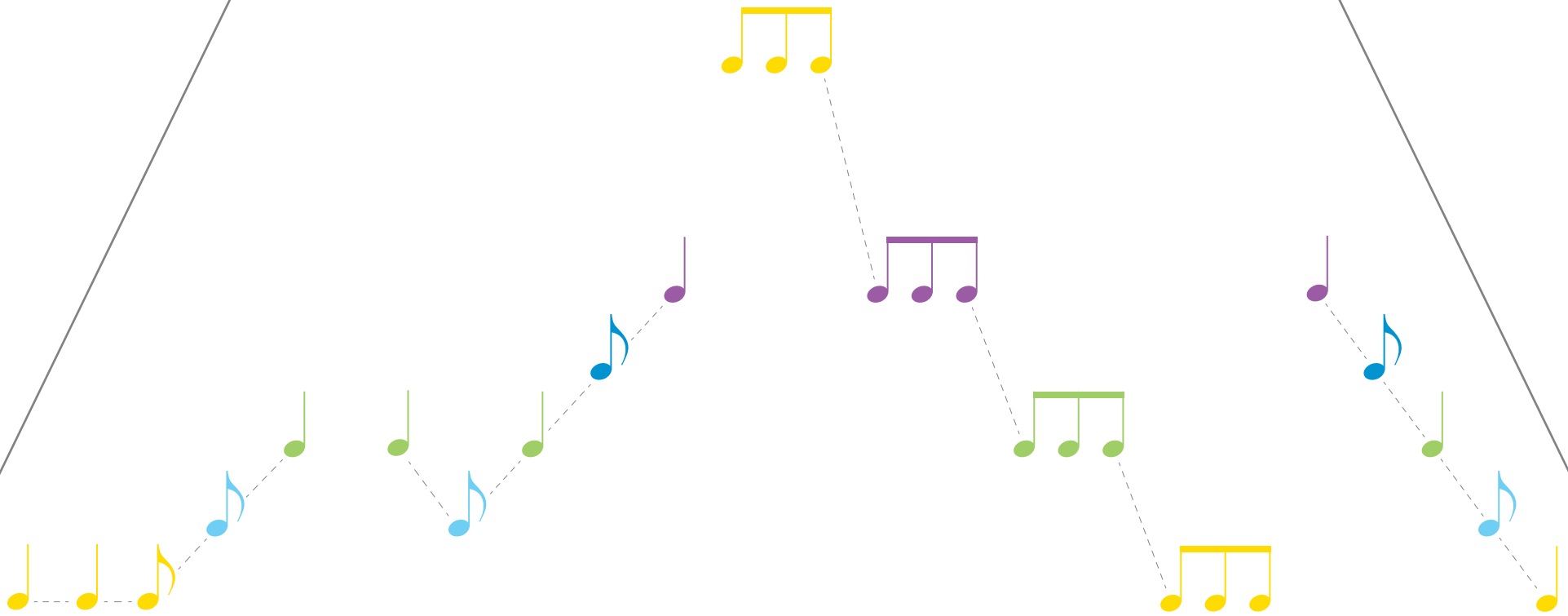
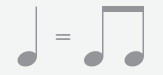

London Bridge Is Falling Down

Ganze Note	○	4 Taktschläge	1 - - -
Halbe Note	○	2 Taktschläge	1 -
Viertelnote	●	1 Taktschläge	1
Achtelnote	♪	1/2 Taktschläge	<u>1</u>
Sechzehntelnote	♪	1/4 Taktschläge	<u><u>1</u></u>

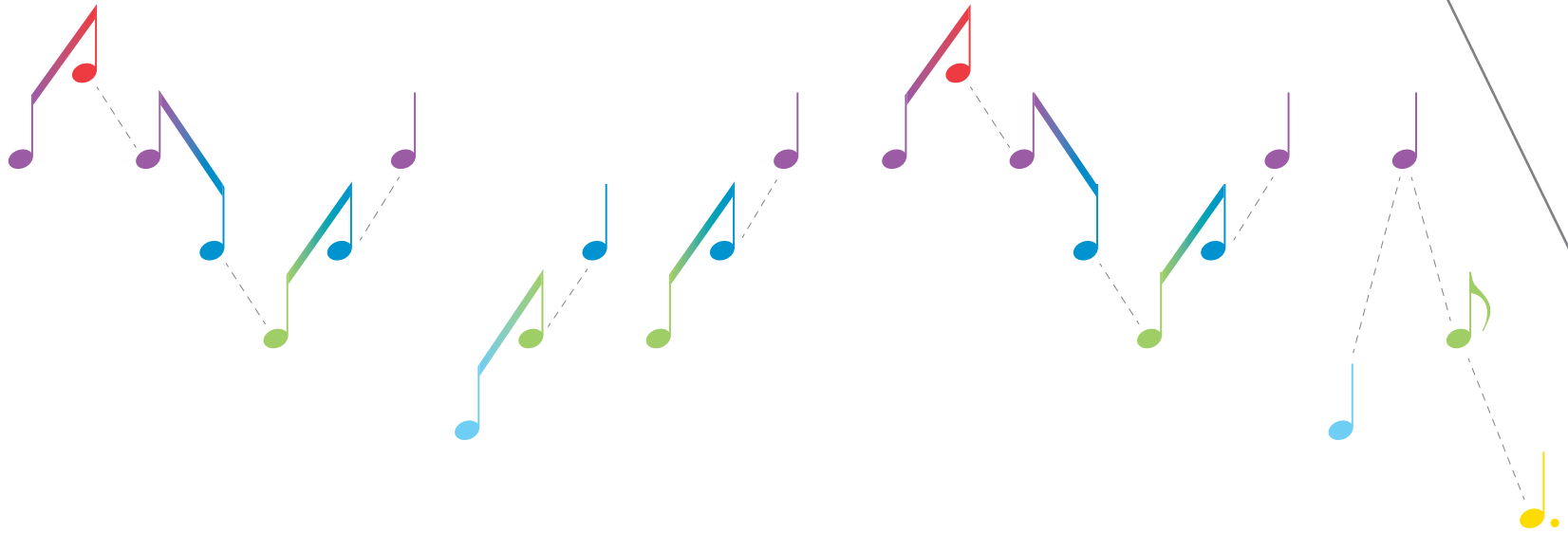

Happy Birthday to You

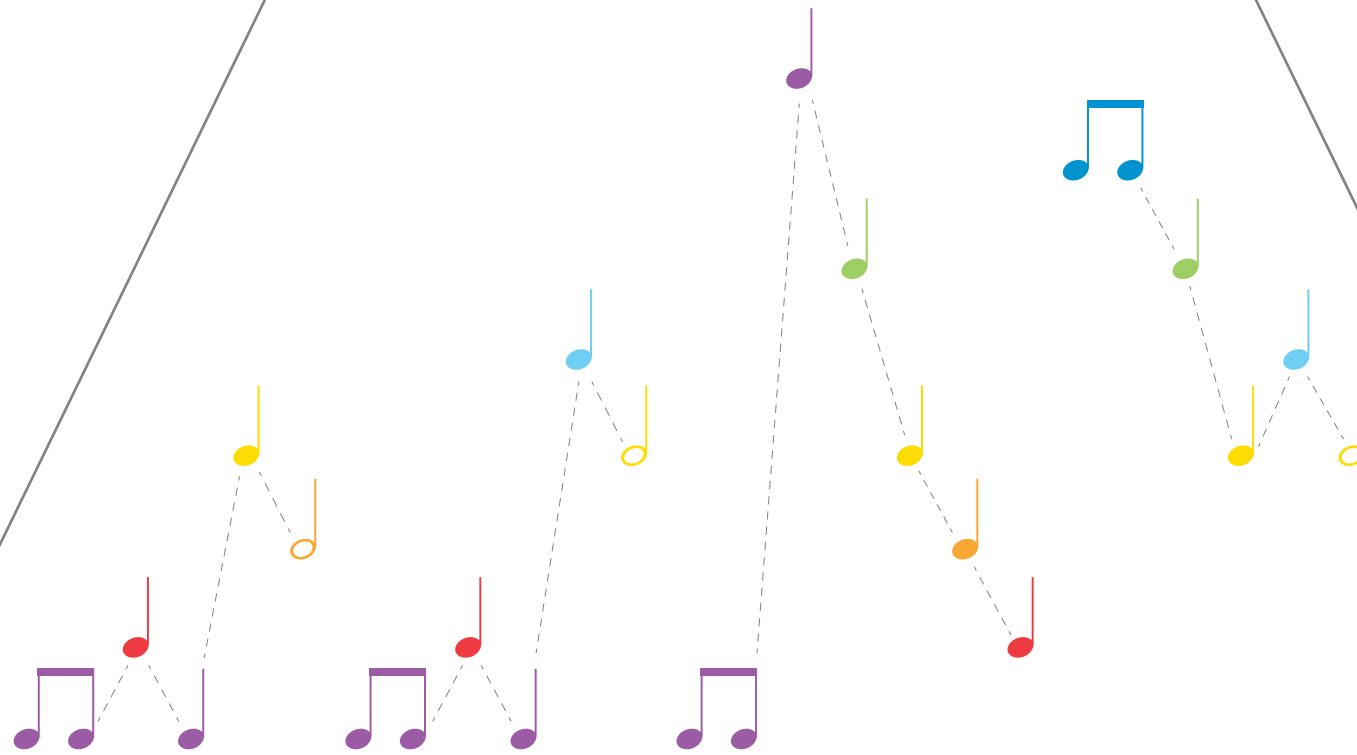

Ganze Note	○	4 Taktschläge	1 - - -
Halbe Note	◐	2 Taktschläge	1 -
Viertelnote	●	1 Taktschläge	1
Achtelnote	♪	1/2 Taktschläge	<u>1</u>
Sechzehntelnote	♫	1/4 Taktschläge	<u><u>1</u></u>



Twinkle, Twinkle, Little Star

Ganze Note	○	4 Taktschläge	1 - - -
Halbe Note	○	2 Taktschläge	1 -
Viertelnote	●	1 Taktschläge	1
Achtelnote	●	1/2 Taktschläge	<u>1</u>
Sechzehntelnote	●	1/4 Taktschläge	<u><u>1</u></u>

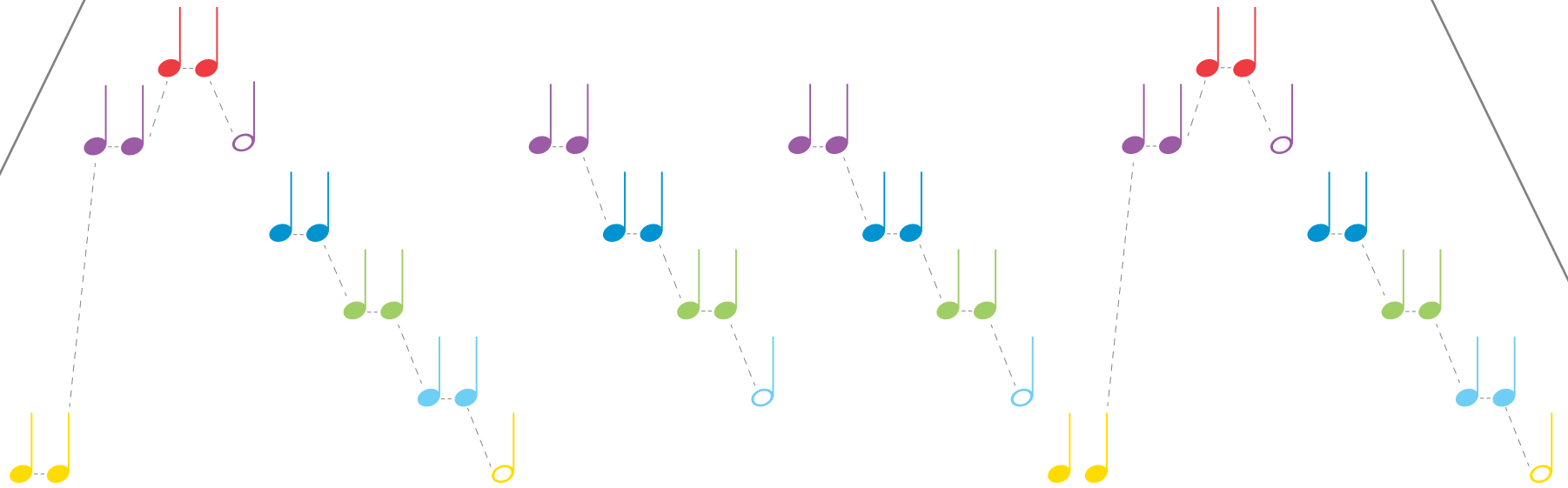
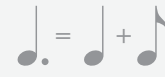
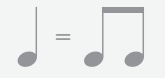

1 2 3 4 5 6 7 i

Do Ti La So Fa Mi Re Do Ti La So Fa Mi Re Do

CONSEILS POUR ACCORDER LA HARPE

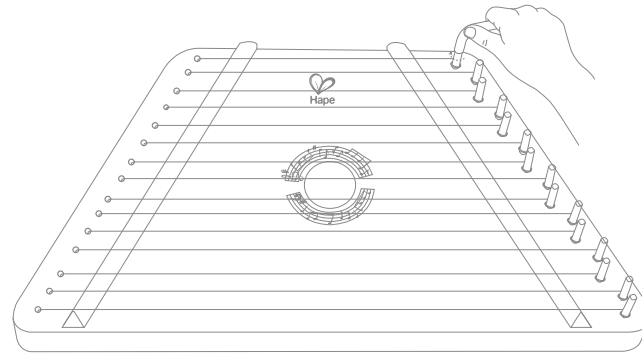

E0323

Comme pour la guitare classique, les cordes de la harpe sont en nylon. Le nylon est beaucoup plus sûr que le métal pour produire les cordes. Cependant, comme tous les instruments professionnels, la harpe devra être accordée lorsque vous l'amènerez chez vous et elle devra également être accordée régulièrement ensuite.

Il existe de nombreux outils d'accordement qui peuvent être utilisés pour régler la harpe. Vous pouvez utiliser un diapason, un piano, un clavier électronique ou tout autre instrument musical qui est déjà correctement accordé. Vous pouvez également télécharger un logiciel d'accordement sur votre téléphone portable.

Pour accorder, choisissez la clé que vous souhaitez utiliser. Puis faites correspondre le son de la clé avec le son de la plus longue corde de la harpe. Une fois que vous avez accordé la première corde, accordez les autres dans l'ordre des notes de la gamme (do, ré, mi, etc.)

Après avoir accordé toutes les cordes dans l'ordre des notes de la gamme, placez une partition de musique et jouez une chanson que vous connaissez bien (nous vous suggérons "Twinkle, Twinkle, Little Star").

Si la chanson sonne juste, cela signifie que vous avez correctement accordé la harpe. Si le son ne sonne pas juste ou si vous ne distinguez pas de différence entre les notes, nous vous recommandons de faire accorder la harpe par un ami musicien ou par un professionnel (dans un magasin de musique ou par un professeur de musique).

COMMENT REMPLACER LES CORDES DE LA HARPE JOYEUSE

Les cordes ne doivent être remplacées que par un adulte. Si vous n'êtes pas sûr(e) de la tâche suivante, veuillez demander de l'aide dans votre magasin de musique local ou auprès d'un professeur de musique.

Vous aurez besoin d'une paire de pinces et d'un coupe-fil.

Nous vous recommandons également de porter des lunettes de sécurité.



Desserrez les chevilles en les tournant sur environ cinq tours complets chacune.



Enfilez la nouvelle corde à travers le trou de la cheville. Pliez la corde après l'avoir insérée à travers la cheville pour la maintenir en place.



Tournez la cheville sur environ cinq tours complets. Assurez-vous que la corde est enroulée sous le trou lorsque vous tournez la cheville.



Après avoir enfilé la corde dans la première cheville, faites passer la corde dans le trou situé à la même hauteur sur le côté gauche de la harpe, en faisant ressortir la corde dans le trou situé juste en dessous. Terminez la deuxième rangée en enfilant la corde dans la deuxième cheville en partant du haut sur le côté droit. Continuez à enfiler les cordes sur les autres rangées en procédant de la même façon pour chaque corde nécessitant d'être remplacée. (Veuillez noter que cette étape n'est pas nécessaire pour la corde du bas puisqu'elle ne possède qu'une seule cheville et qu'un seul trou.)

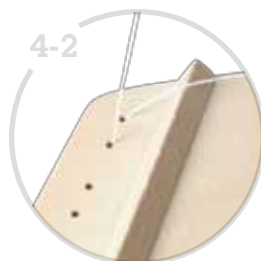

Répétez les étapes 2 et 3 pour resserrer une autre cheville.

Utilisez un coupe-fil pour couper tout excédent de corde et pliez soigneusement l'extrémité de la corde vers le bas pour protéger le joueur de la pointe de la corde.

Utilisez régulièrement ces conseils pour accorder la harpe joyeuse.



Harpe Joyeuse

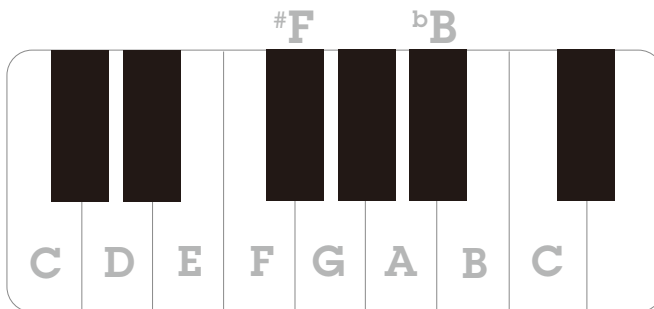

G Do 1
 #F Ti 7
 E La 6
 D So 5
 C Fa 4
 B Mi 3
 A Re 2
 G Do 1
 #F Ti 7
 E La 6
 D So 5
 C Fa 4
 B Mi 3
 A Re 2
 G Do 1

i Do F
 7 Ti E
 6 La D
 5 So C
 4 Fa bB
 3 Mi A
 2 Re G
 i Do F
 7 Ti E
 6 La D
 5 So C
 4 Fa bB
 3 Mi A
 2 Re G
 1 Do F

Noms des notes

Numéros

Notes en lettres

CLÉ DE "C"

CLÉ DE "D"

CLÉ DE "E"

CLÉ DE "F"

CLÉ DE "G"

Do	Re	Mi	Fa	So	La	Ti	5 So C
1	2	3	4	5	6	7	
C	D	E	F	G	A	B	4 Fa bB
D	E	#F	G	A	B	#C	3 Mi A
E	#F	#G	A	B	#C	#D	2 Re G
F	G	A	bB	C	D	E	1 Do F
G	A	B	C	D	E	#F	

APPRENDRE À JOUER DE LA HARPE JOYEUSE

Jouer de la harpe joyeuse est une activité idéale parent-enfant afin d'initier les enfants à la musique et leur permettre de jouer leur propre musique. De plus, la harpe joyeuse est un instrument formidable pour les enfants de tout âge afin de développer leur coordination et leur motricité fine. Aidez votre enfant à apprendre à lire à l'aide de ces activités et exercices :

- Les chansons incluses avec la harpe joyeuse offre plusieurs niveaux de difficulté. Choisissez une ou deux des chansons les plus faciles que votre enfant connaît bien et chantez ces chansons ensemble en lui présentant la gamme musicale.
- Pincez les cordes de la harpe joyeuse, en commençant par la corde du bas jusqu'à la corde du haut, et demandez à votre enfant de faire la même chose. Il s'agit de les aider à apprendre la différence entre les notes.
- En commençant par les mêmes chansons que vous avez chanté ensemble, placez une partition de musique sous les cordes de la harpe joyeuse et jouez la première phrase de la chanson. Par exemple, si vous avez chanté " Twinkle, Twinkle, Little Star", suivez les notes de la partition pour jouer " Twinkle, Twinkle, Little Star ". Puis, demandez à votre enfant de faire la même chose .
- Jouez tout le morceau jusqu'à la fin, en insistant sur l'idée de pincer la corde au-dessus de chaque note pour jouer le morceau et laissez votre enfant jouer toute la chanson .
- Aidez votre enfant à comprendre que cela peut ne pas sembler parfait au début, mais qu'avec un peu de pratique, la harpe joyeuse transformera votre enfant en un grand musicien!

Harpe Joyeuse

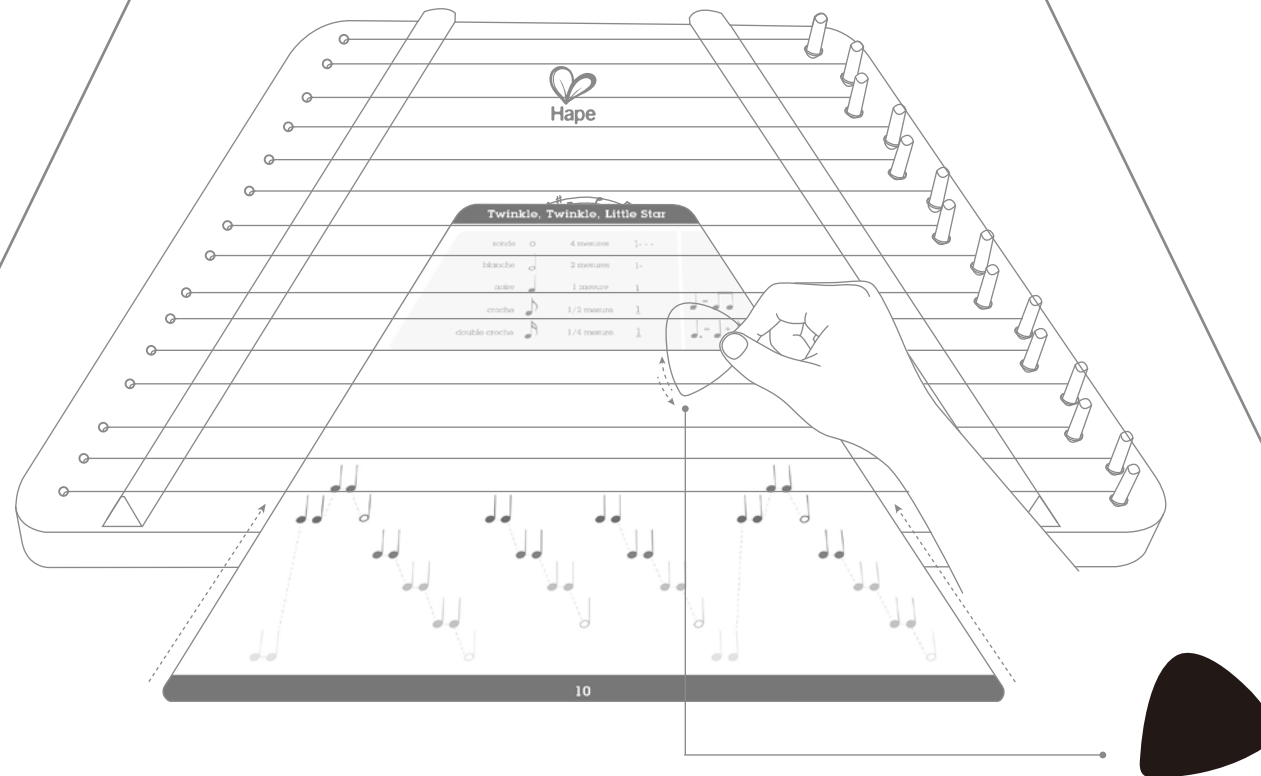

- Choisis une chanson parmi les huit partitions incluses et insère-la sous les cordes sur la harpe.
- Assure-toi que la partition en forme de trapèze s'adapte parfaitement sur la plate-forme en bois. Les cordes seront parallèles aux notes de la partition.
- Joue de la musique avec le plectre fourni, de gauche à droite selon les notes colorées. Chaque note indique la corde à pincer.
- Joue légèrement pour obtenir une tonalité mélodique avec la main gauche ou la main droite.
- Déplace ta main vers le haut ou vers le bas pour pincer les autres cordes afin de créer une chanson harmonique.
 - Pratique le rythme jusqu'à ce que tu puisses jouer parfaitement une chanson.
 - Puis joue devant tes parents pour leur montrer tes merveilleuses compétences.

Mary Had a Little Lamb

ronde	○	4 mesures	1 - - -
blanche	○	2 mesures	1 -
noire	●	1 mesure	1
croche	♪	1/2 mesure	<u>1</u>
double croche	♪	1/4 mesure	<u><u>1</u></u>

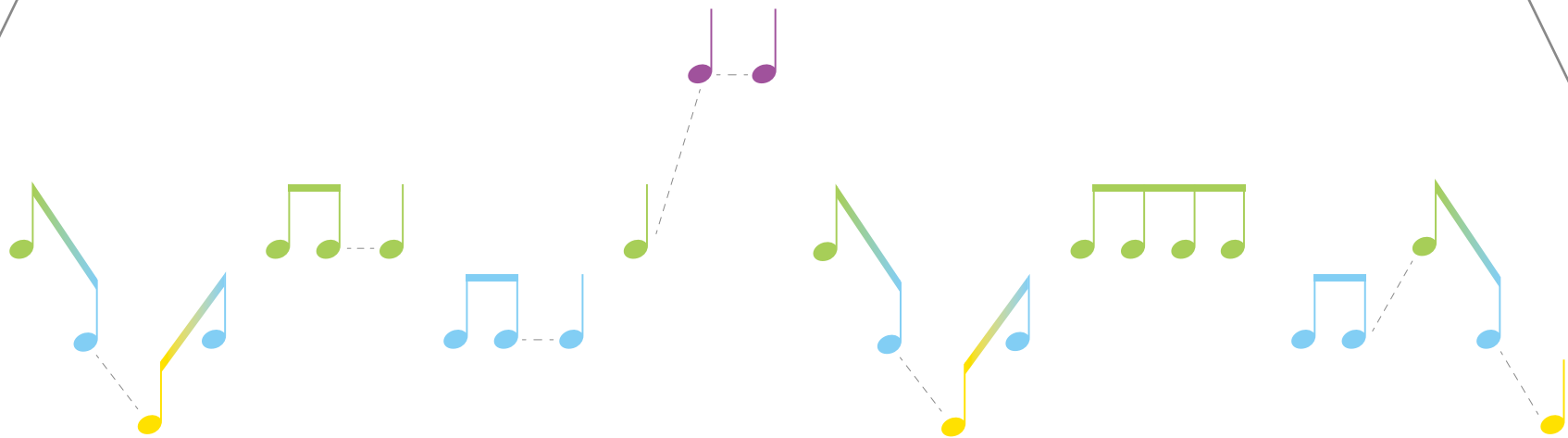
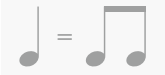

London Bridge Is Falling Down

ronde	○	4 mesures	1 - - -
blanche	○	2 mesures	1 -
noire	●	1 mesure	1
croche	♪	1/2 mesure	<u>1</u>
double croche	♪♪	1/4 mesure	<u><u>1</u></u>

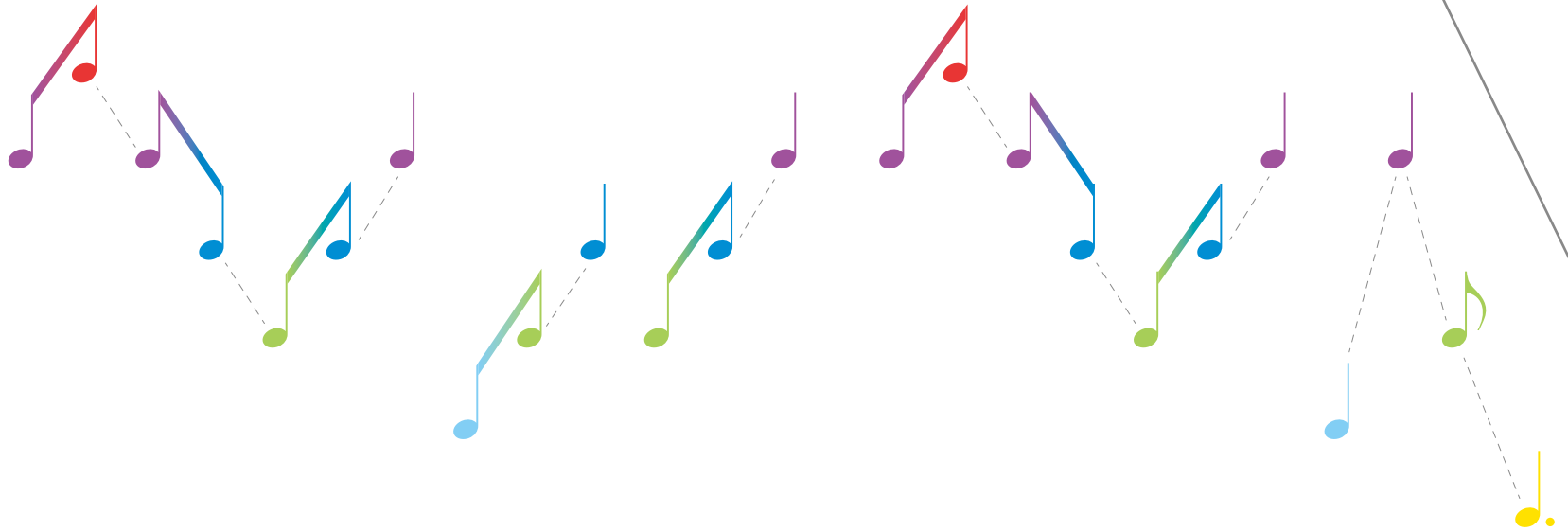
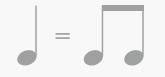

Happy Birthday to You

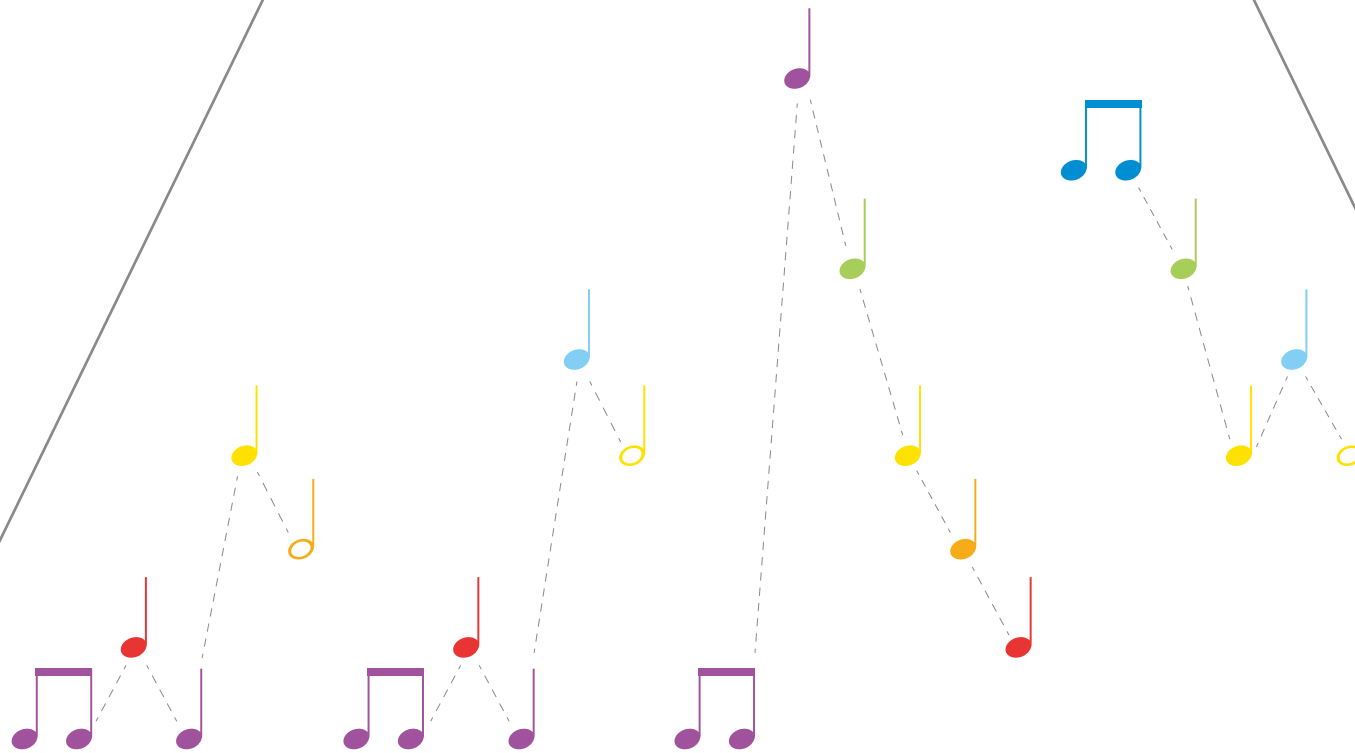

ronde		4 mesures	1 - - -
blanche		2 mesures	1 -
noire		1 mesure	1
croche		1/2 mesure	<u>1</u>
double croche		1/4 mesure	<u><u>1</u></u>



Twinkle, Twinkle, Little Star

ronde	○	4 mesures	1 - - -
blanche	○	2 mesures	1 -
noire	●	1 mesure	1
croche	♪	1/2 mesure	<u>1</u>
double croche	♫	1/4 mesure	<u>1</u>

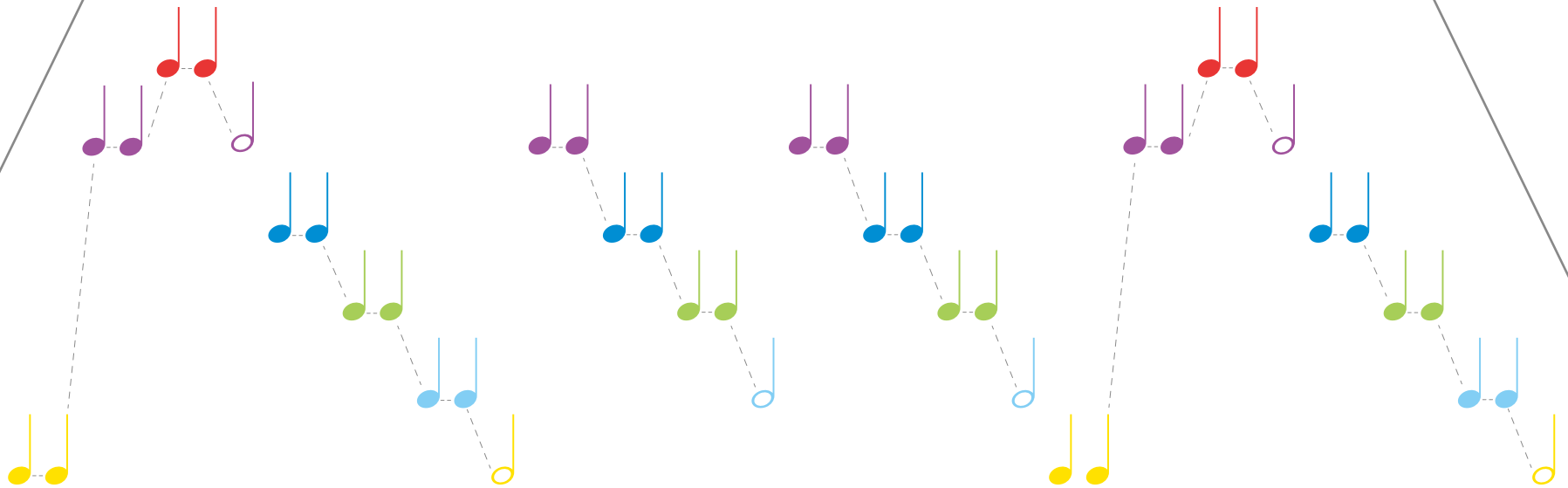
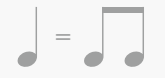

A large triangular musical staff with 10 horizontal lines. The staff is divided into two sections by a horizontal line. The top section has 5 lines and the bottom section has 5 lines. The staff is used for writing musical notation, with numbers 1-7 and letters Do-Ti on the left and right sides.

Line	Left Label	Right Label
10	1	Do
9	2	Re
8	3	Mi
7	4	Fa
6	5	So
5	6	La
4	7	Ti
3	i	Do
2	i	Re
1	i	Do

TRUCOS MELÓDICOS

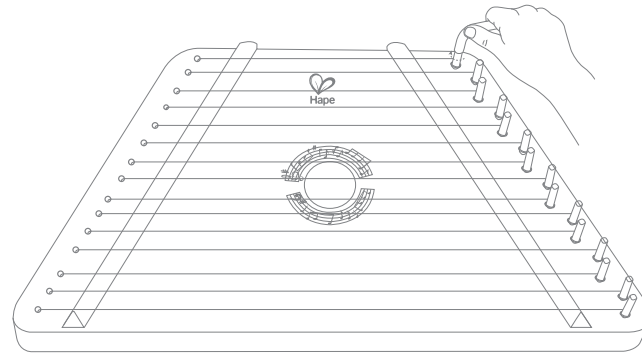

E0323

La cuerda está hecha de Nilón, como en la guitarra clásica. El Nilón es un material más seguro que el de las cuerdas de metal. Sin embargo, como todos los instrumentos profesionales, tu arpa se deberá afinar una vez te la hayas llevado a tu casa y esto lo deberás repetir periódicamente.

Hay muchas maneras de afinar tu arpa; puedes utilizar un diapasón, un piano, un teclado electrónico o cualquier otro instrumento musical que esté afinado correctamente. También puedes descargar una aplicación en tu móvil.

Primero de todo escoge una nota cualquiera. Entonces haz coincidir el tono de esta nota con el tono de la cuerda más larga del arpa. Una vez hayas afinado la primera cuerda, ajusta las otras cuerdas secuencialmente hacia arriba (do, re, mi, etc.).

Una vez hayas afinado todas las cuerdas, inserta una partitura y toca la canción que más familiar te sea (nosotros te sugerimos Twinkle, Twinkle, Little Star).

Si la canción suena bien significa que has afinado tu arpa correctamente. Si no suena bien o no puedes diferenciar los tonos, te recomendamos que te afine el arpa un amigo o un profesional que esté familiarizado con la música (tienda de instrumentos o un profesor de música)

CÓMO REEMPLAZAR LAS CUERDAS TU ARPA FELIZ

Solamente un adulto puede reemplazar las cuerdas. Si no te ves capaz de hacer esta tarea, por favor pide ayuda en una tienda de instrumentos o a un profesor de música.

Necesitarás unas alicates y un cortacables.

También te recomendamos que utilices unas gafas de protección.

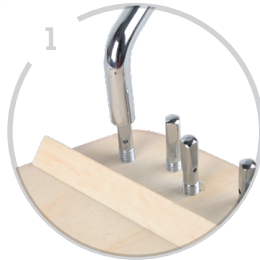

Aloja las clavijas dando aproximadamente cinco vueltas completas.

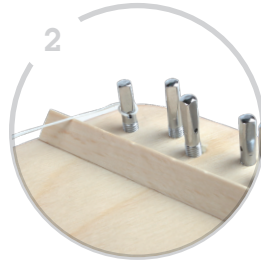

Enhebra la cuerda en los agujeros de las clavijas. Dobra la cuerda después de insertarla en el agujero para mantenerla en posición.

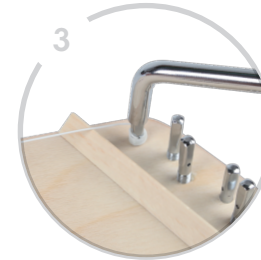

Aprieta la clavija dando aproximadamente cinco vueltas completas. Asegúrate que la cuerda queda enrollada debajo el agujero de la clavija.

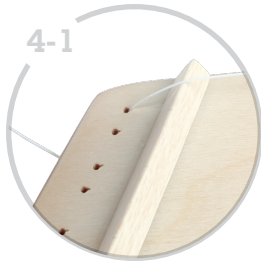

Una vez hayas enhebrado la primera clavija, enhebra la cuerda en el agujero que queda a la parte izquierda del arpa y lleva la cuerda justo dentro del agujero. Vuelve a pasar la cuerda por el segundo agujero de la parte trasera del arpa de manera que puedas enhebrar la cuerda de nuevo en la segunda clavija de la parte delantera del arpa (Ten en cuenta que este paso no es necesario en la cuerda de la parte de abajo del arpa porque solamente tiene una clavija y un agujero).

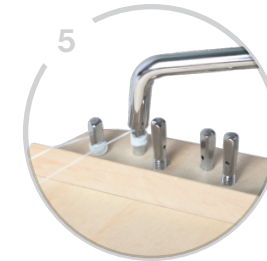
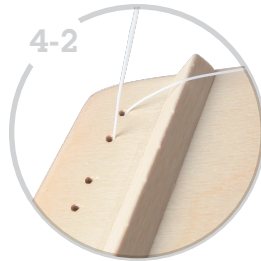

Repite los pasos 2 y 3 para apretar las otras clavijas.

Utiliza unas alicates para cortar la cuerda sobrante y dobla cuidadosamente la punta de la cuerda hacia abajo. Utiliza el los Trucos Melódicos del Arpa Feliz para afinar tu instrumento correctamente.

APRENDER A TOCAR EL ARPA FELIZ

Tocar el Arpa Feliz es una actividad ideal entre padres e hijos para introducir la música a los niños así como darles la oportunidad de hacer música por su propia cuenta. Además, el Arpa Feliz es una gran herramienta para que niños de todas las edades desarrollen la coordinación y las habilidades motoras. Ayuda a tus hijos a aprender y a jugar a través de estas actividades y ejercicios:

- Ordena las canciones incluidas en el Arpa Feliz por su dificultad. Escoged la canción o canciones más fáciles y conocidas y cantad la canción introduciendo la escala musical.
- Puntea las cuerdas del Arpa Feliz empezando por la cuerda de abajo y que tu hijo haga lo mismo. Esto les ayuda a aprender la diferencia de tonalidad entre las notas.
- Empezando con las mismas canciones que habéis cantado juntos, pon una partitura debajo las cuerdas del Arpa Feliz y toca la primera frase musical de la canción. Por ejemplo, si cantáis Twinkle, Twinkle, Little Star, sigue las notas de la partitura para tocar Twinkle, Twinkle, Little Star. Seguidamente, que tu hijo haga lo mismo.
- Toca la canción hasta el final, enfatizando en puntear la cuerda encima de cada nota para crear la canción y después deja tocar a tu hijo la canción entera.
- Ayuda a tu hijo a comprender que quizás la canción no suena perfecta la primera vez, pero que con un poco de paciencia, el Arpa Feliz puede hacer que cualquier niño parezca un músico profesional.

ARPA FELIZ

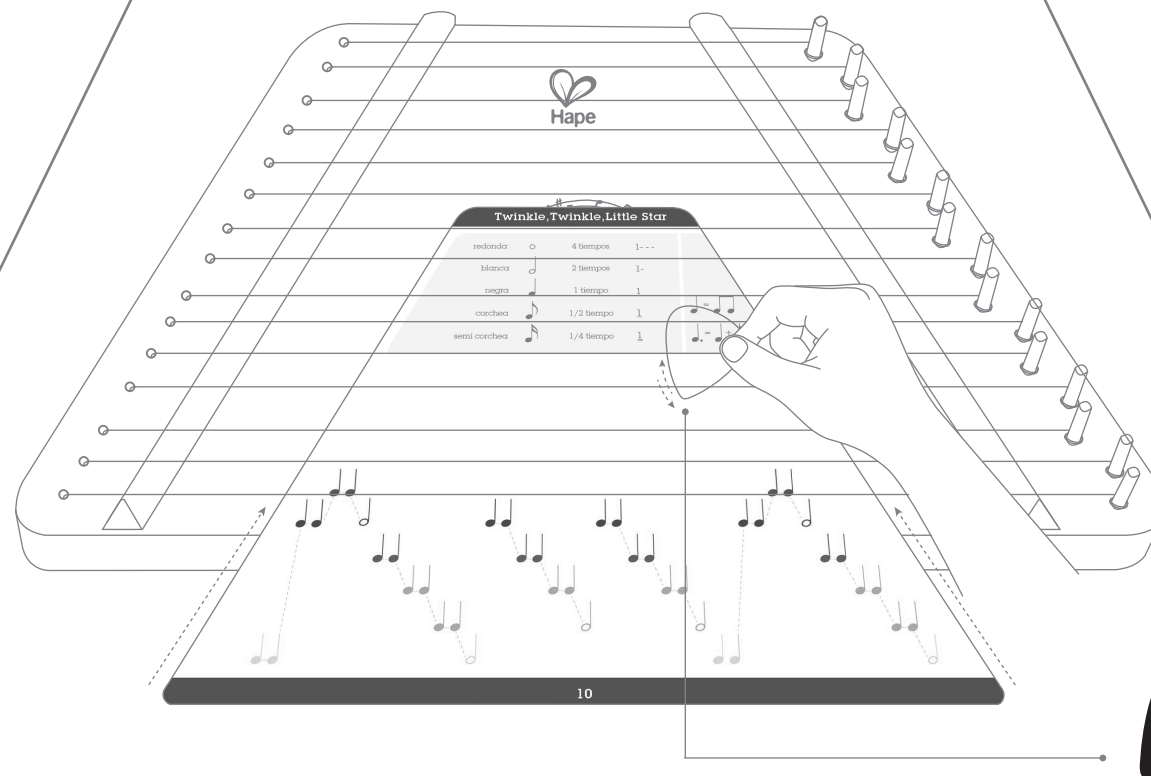

- Selecciona una canción entre las ocho partituras y colócala debajo de las cuerdas y encima del arpa.
 - Asegúrate que la partitura en forma de trapecio queda perfectamente colocada en la plataforma de madera. Las cuerdas quedarán paralelas a las notas de la partitura.
 - Toca la canción con la púa de izquierda a derecha según las notas coloreadas. Cada nota sonará cuando puntees la cuerda correspondiente.
 - Toca suavemente para que suene un tono melódico.
 - Desliza la púa entre las cuerdas para que suene una canción armónica.
 - Practica el ritmo hasta que toques una canción perfecta.
 - Toca para tus padres y comparte tus maravillosas habilidades.

Mary Had a Little Lamb

redonda	○	4 tiempos	1 - - -
blanca	◐	2 tiempos	1 -
negra	●	1 tiempo	1
corchea	♪	1/2 tiempo	<u>1</u>
semi corchea	♫	1/4 tiempo	<u><u>1</u></u>





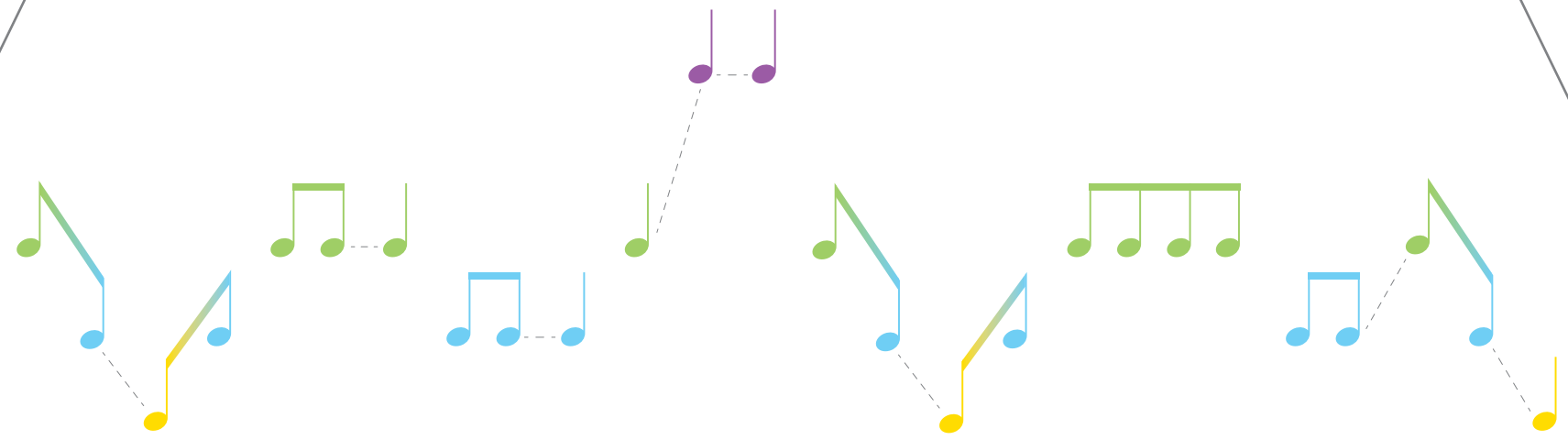

Row, Row, Row Your Boat

redonda	○	4 tiempos	1 - - -
blanca	○	2 tiempos	1 -
negra	●	1 tiempo	1
corchea	♪	1/2 tiempo	<u>1</u>
semi corchea	♫	1/4 tiempo	<u><u>1</u></u>

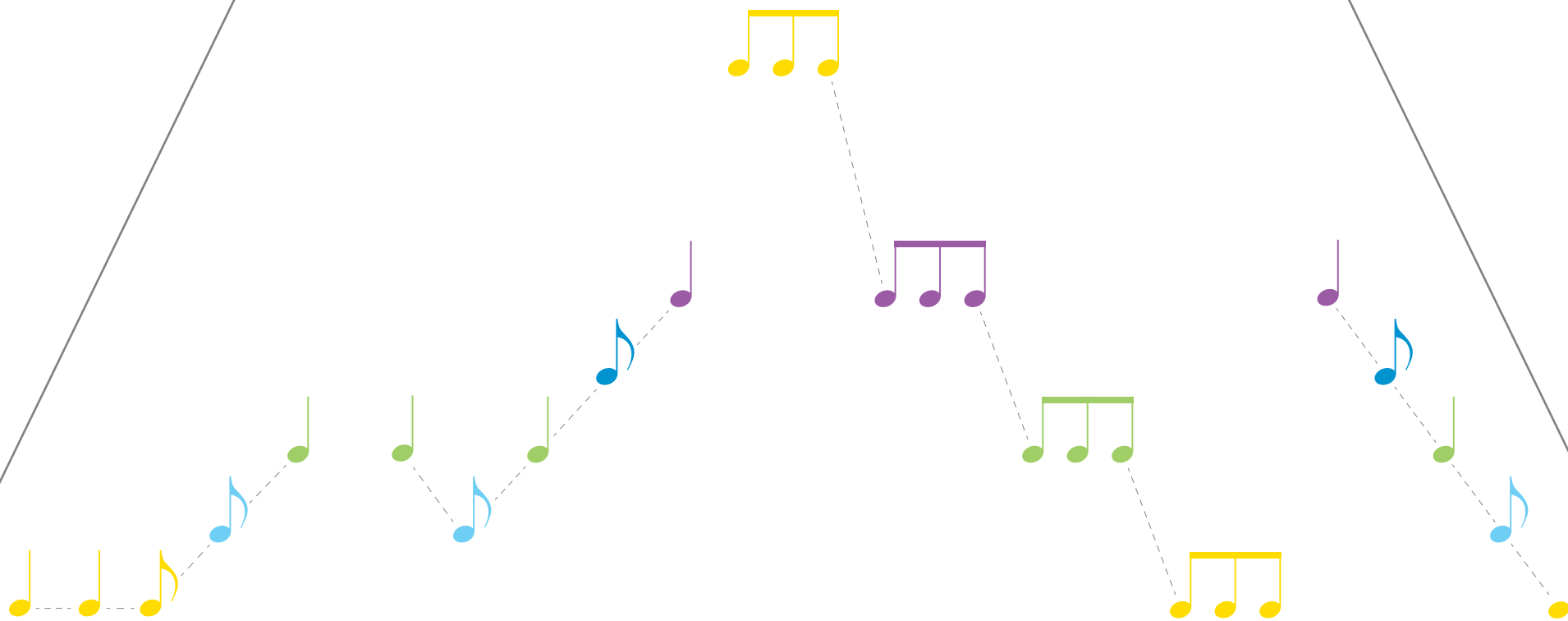
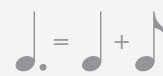
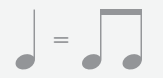

London Bridge Is Falling Down

redonda	○	4 tiempos	1 - - -
blanca	○	2 tiempos	1 -
negra	●	1 tiempo	1
corchea	♪	1/2 tiempo	<u>1</u>
semi corchea	♫	1/4 tiempo	<u><u>1</u></u>

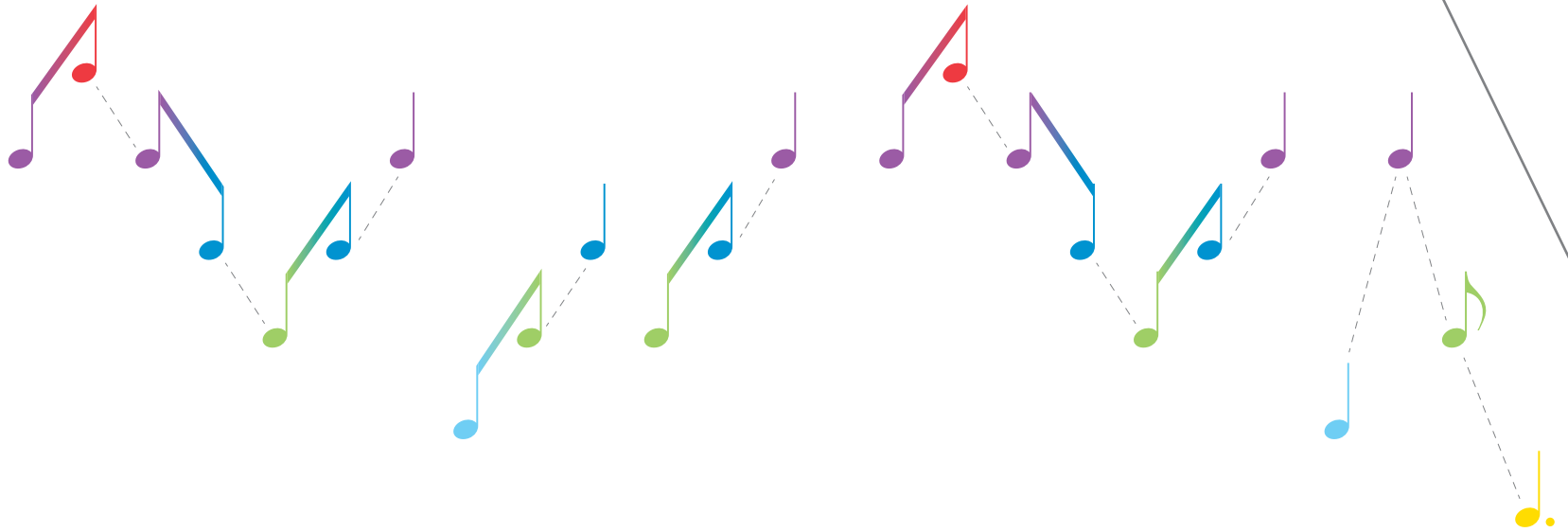
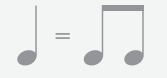

Happy Birthday to You

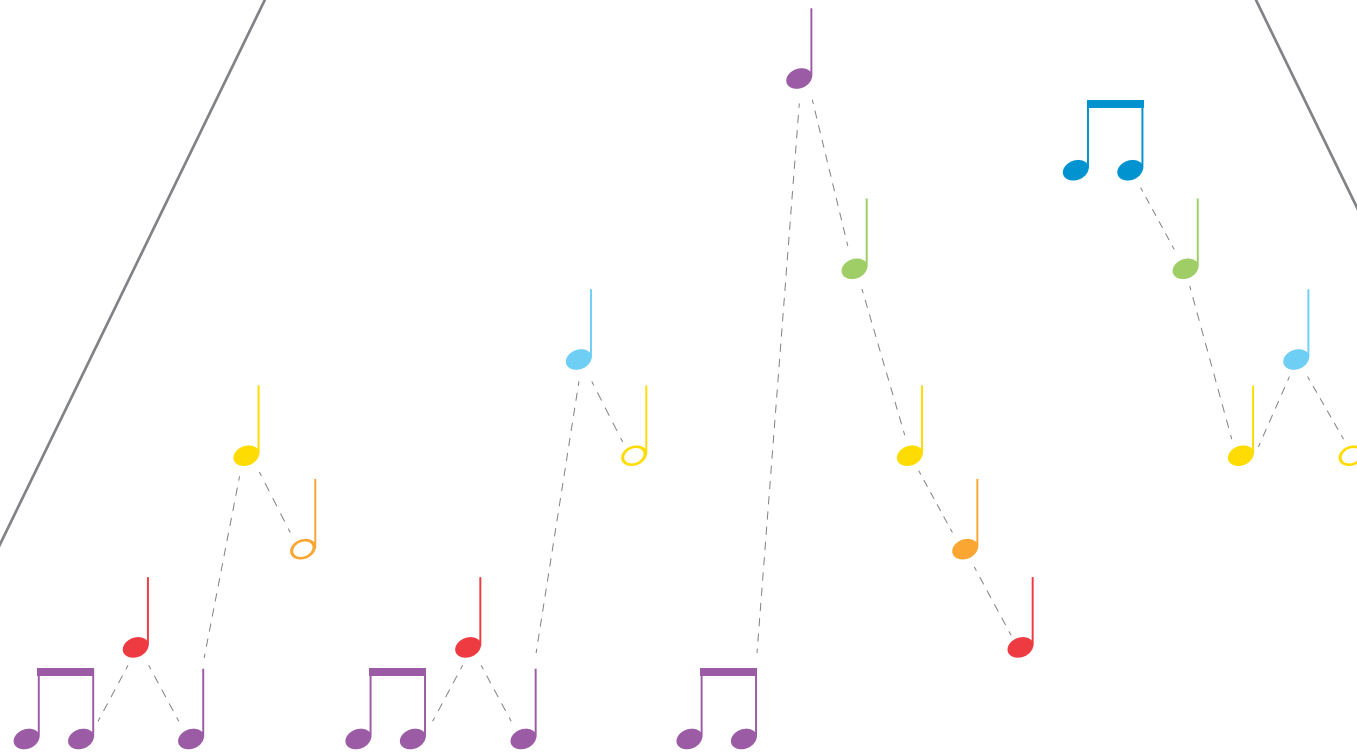

redonda		4 tiempos	1 - - -
blanca		2 tiempos	1 -
negra		1 tiempo	1
corchea		1/2 tiempo	<u>1</u>
semi corchea		1/4 tiempo	<u><u>1</u></u>

=
 = +

Do
Ti
La
So
Fa
Mi
Re
Do
Ti
La
So
Fa
Mi
Re
Do

ACCORDATURA

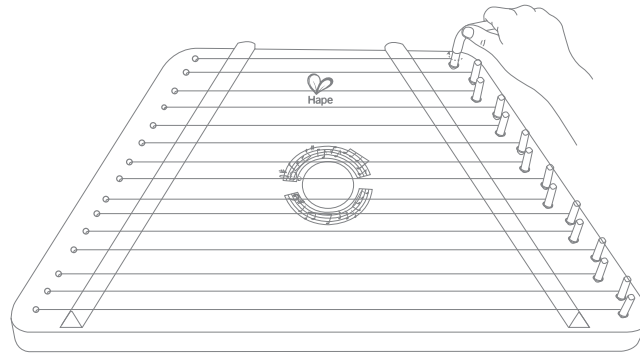

E0323

Le corde della Piccola cetra, come quelle della chitarra classica, sono in nylon, un materiale molto più sicuro del metallo. Come tutti gli strumenti per uso professionale, la Piccola cetra dovrà essere accordata prima del primo utilizzo e più volte anche in seguito.

Per accordare la Piccola cetra è possibile utilizzare una serie di strumenti: un accordatore a fiato, un diapason, un pianoforte, una tastiera elettronica o qualsiasi altro strumento musicale ben accordato. È possibile scaricare sul cellulare il software apposito.

Per accordare lo strumento, scegli una nota quindi falla corrispondere al suono prodotto dalla corda più lunga della cetra. Dopo aver accordato la prima corda, regola le altre corde seguendo la scala musicale (do, re, mi, ecc.).

Quando tutte le corde saranno accordate correttamente, inserisci uno spartito ed esegui una canzone che conosci (come "Twinkle, Twinkle, Little Star").

Se il brano viene riprodotto correttamente, la Piccola cetra è ben accordata. In caso contrario o se non riesci a cogliere la differenza, chiedi aiuto a un amico o a un esperto (puoi rivolgerti a un negozio di strumenti musicali o a un insegnante di musica).

COME SOSTITUIRE LE CORDE DELLA PICCOLA CETRA

La sostituzione delle corde deve essere eseguita da un adulto. Se non ti è chiaro il procedimento descritto di seguito, puoi rivolgerti a un negozio di strumenti musicali o a un insegnante di musica.

Ti serviranno un paio di pinzette e un tagliafilì.

Ti consigliamo inoltre di indossare degli occhiali protettivi.



1
Allenta i piroli compiendo circa cinque giri completi.

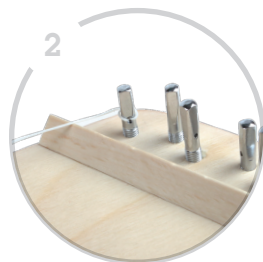

2
Infila la corda nel foro del pirolo. Piega la corda dopo averla inserita nel pirolo per bloccarla in posizione.

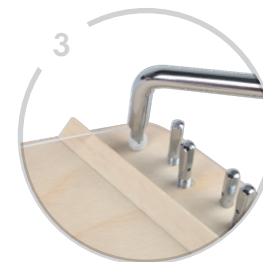

3
Stringi di nuovo il pirolo compiendo circa cinque giri completi. Assicurati che la corda sia arrotolata sotto il foro posto nel pirolo.

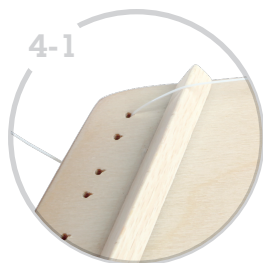

4-1
Dopo aver infilato la corda nel primo pirolo, falla passare attraverso il foro parallelo sul lato sinistro della cetra e falla uscire verso l'alto attraverso il foro posto subito al di sotto.

Completa la seconda fila infilando il secondo pirolo dall'alto, sul lato destro. Continua a infilare le corde da sostituire procedendo nello stesso modo. (Tieni presente che questo passaggio non è necessario nel caso dell'ultima corda, che ha un solo pirolo e un solo foro.)

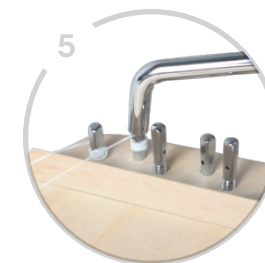
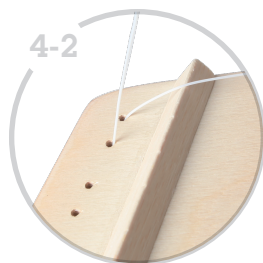

5
Ripeti i passaggi 2 e 3 per fissare un'altra corda.

Taglia la corda in eccesso con il tagliafilì e piega con cautela l'estremità della corda verso il basso per evitare danni provocati dalla punta metallica. Ricorda di accordare la Piccola cetra regolarmente.



Happy Harp

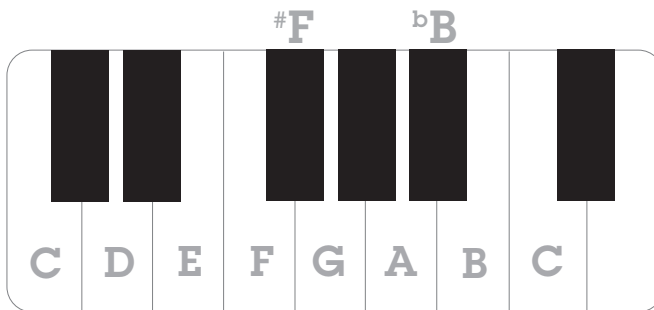

G Do 1		i Do F
A Re 2		7 Ti E
B Mi 3		6 La D
C Fa 4		5 So C
D So 5		4 Fa bB
E La 6		3 Mi A
F Ti 7		2 Re G
G Do 1		i Do F
A Re 2		7 Ti E
B Mi 3		6 La D
C Fa 4		5 So C
D So 5		4 Fa bB
E La 6		3 Mi A
F Ti 7		2 Re G
G Do 1		i Do F

I nomi delle note

Notazione musicale numerata

Le note sull'accordatore a fiato

CHIAVE DI "C"

CHIAVE DI "D"

CHIAVE DI "E"

CHIAVE DI "F"

CHIAVE DI "G"

Do	Re	Mi	Fa	So	La	Ti			
1	2	3	4	5	6	7			
C	D	E	F	G	A	B			
D	E	#F	G	A	B	#C			
E	#F	#G	A	B	#C	#D			
F	G	A	bB	C	D	E			
G	A	B	C	D	E	#F			

IMPARARE A SUONARE LA PICCOLA CETRA

Suonare la Piccola cetra è un'attività che coinvolge genitori e bambini, illustra le basi della musica e consente ai bambini di comporre liberamente. Inoltre, la Piccola cetra è uno strumento perfetto per lo sviluppo della coordinazione e delle abilità motorie fini dei bambini di ogni età. Ecco alcune attività ed esercizi utili per imparare a suonare:

- Le canzoni che accompagnano la Piccola cetra presentano diversi livelli di difficoltà. È opportuno scegliere una o due canzoni facili che il bambino conosce e cantare insieme per presentargli la scala musicale.
- Pizzicare le corde della Piccola cetra procedendo dal basso verso l'alto e chiedere al bambino di fare lo stesso, per aiutarlo a cogliere la differenza tra le note.
- Cominciando con lo stesso brano cantato insieme, appoggiare uno spartito sotto le corde della Piccola cetra ed eseguire la prima frase. Per esempio, dopo aver cantato "Twinkle, Twinkle, Little Star", seguire le note sullo spartito per eseguire "Twinkle, Twinkle, Little Star". Quindi chiedere al bambino di ripetere.
- Eseguire la canzone fino alla fine, chiedendo al bambino di pizzicare la corda posta sopra ciascuna nota per creare la melodia per poi lasciargli suonare l'intero brano.
- Aiutare il bambino a comprendere che all'inizio l'esecuzione potrebbe non essere perfetta, ma che con un po' di pratica la Piccola cetra lo aiuterà a diventare un vero maestro!

Happy Harp

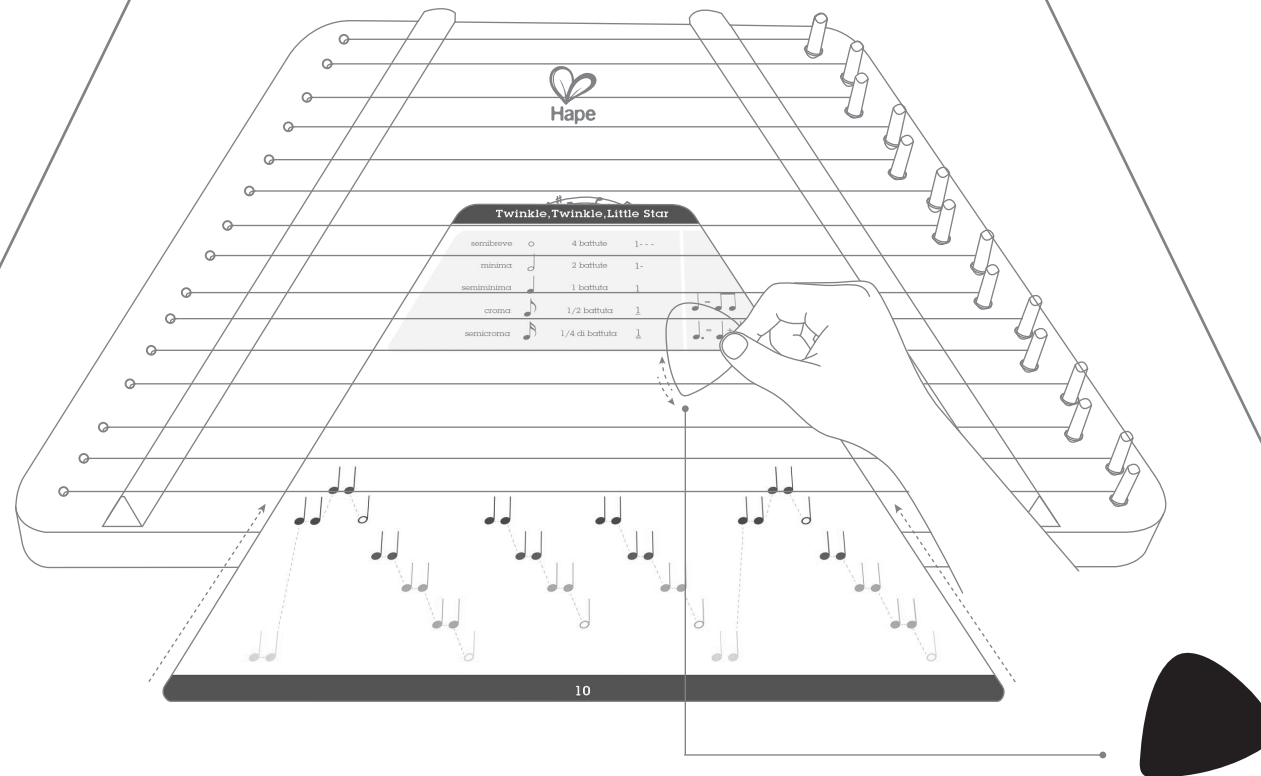

- Scegli uno degli otto spartiti inclusi e inseriscilo sotto le corde.
- Verifica che lo spartito, che ha la forma di un trapezio, coincida con la forma della base di legno. Le corde saranno parallele alle note stampate sullo spartito.
- Esegui il brano con il plettro incluso, pizzicando le corde da sinistra a destra, seguendo le note colorate. La corda va pizzicata in corrispondenza di ogni nota.
- Un tocco delicato, con la mano sinistra o destra, produrrà una melodia piacevole.
 - Per creare l'armonia, spostati sulle corde verso l'alto o verso il basso.
 - Esercitati con il ritmo finché il brano non ti sembra perfetto.
- E ora esibisciti davanti ai tuoi genitori per mostrare le tue grandi qualità.

Mary Had a Little Lamb

semibreve	○	4 battute	1 - - -
minima	◡	2 battute	1 -
semiminima	◡	1 battuta	1
croma	◡	1/2 battuta	<u>1</u>
semicroma	◡	1/4 di battuta	<u><u>1</u></u>

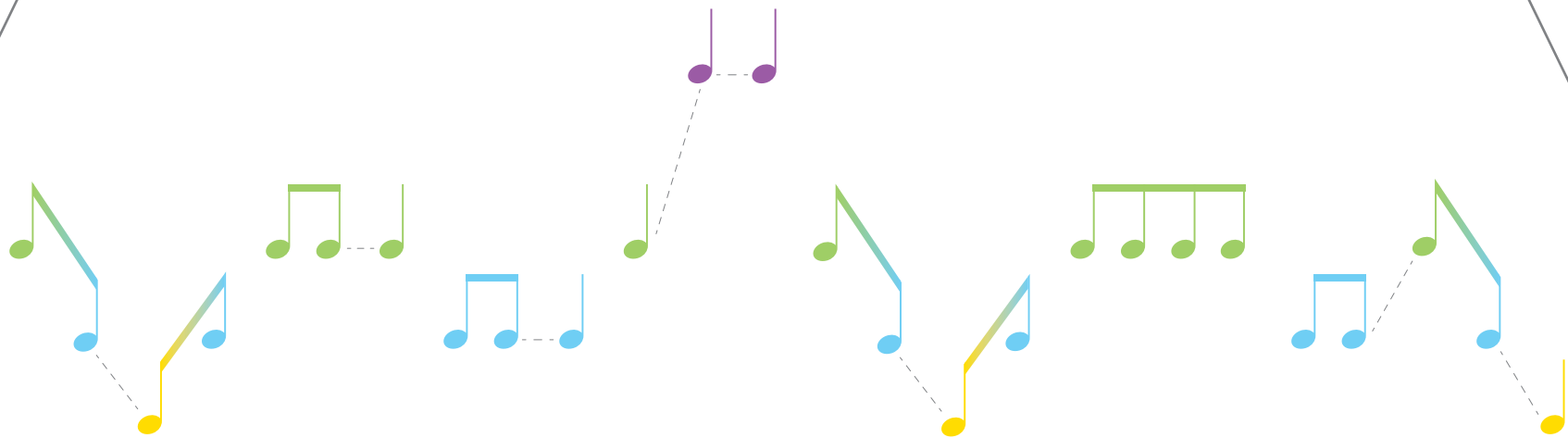
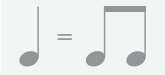

Row, Row, Row Your Boat

semibreve	○	4 battute	1 - - -
minima	♪	2 battute	1 -
semiminima	♪	1 battuta	1
croma	♪	1/2 battuta	<u>1</u>
semicroma	♪	1/4 di battuta	<u>1</u>

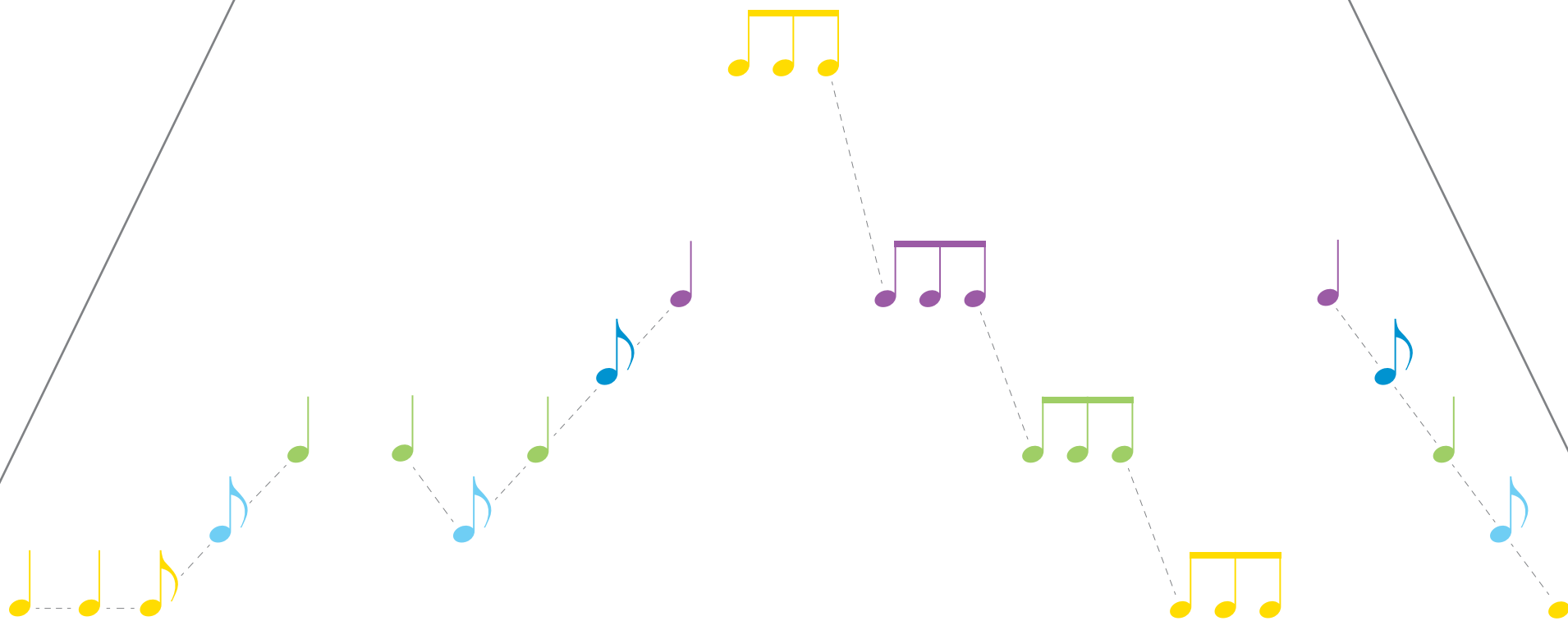
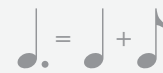
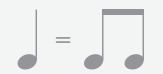



London Bridge Is Falling Down



semibreve ○ 4 battute 1 - - -

minima  2 battute 1 -

semiminima  1 battuta 1

croma  1/2 battuta 1

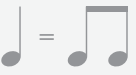
semicroma  1/4 di battuta 1

 = 

 =  + 

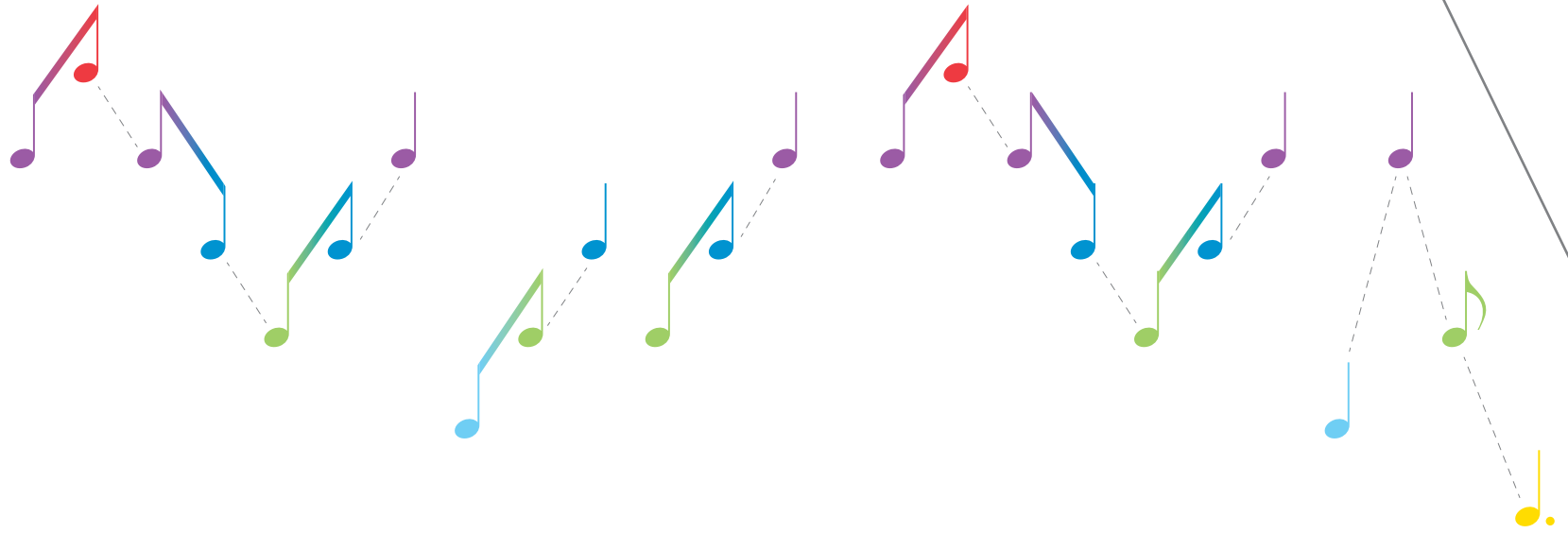

Happy Birthday to You

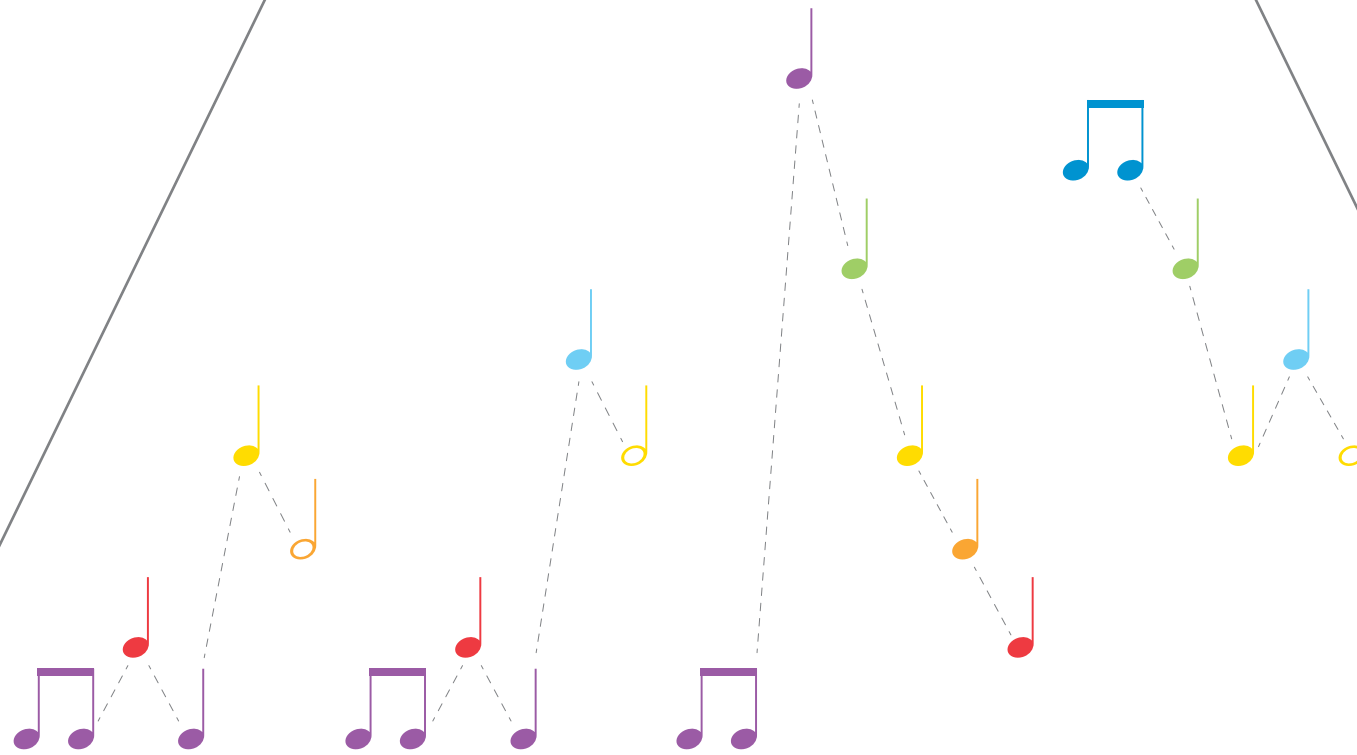

semibreve		4 battute	1 - - -
minima		2 battute	1 -
semiminima		1 battuta	1
croma		1/2 battuta	<u>1</u>
semicroma		1/4 di battuta	<u><u>1</u></u>

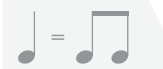

Twinkle, Twinkle, Little Star

semibreve	○	4 battute	1 - - -
minima	♪	2 battute	1 -
semiminima	♫	1 battuta	1
croma	♮	1/2 battuta	<u>1</u>
semicroma	♯	1/4 di battuta	<u>1</u>

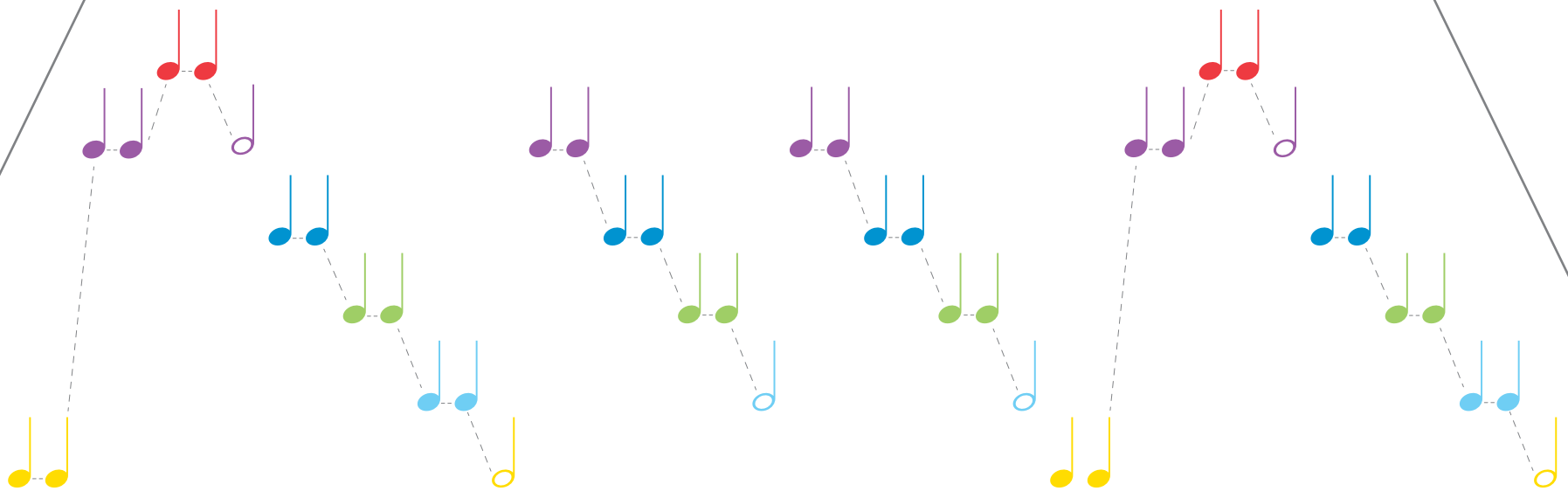
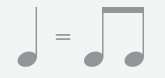

The diagram shows a large, inverted triangle-shaped musical staff with 12 horizontal lines. The staff is divided into two sections by a horizontal line. The top section has 6 lines, and the bottom section has 6 lines. The staff is filled with a light gray grid. The notes are labeled with numbers 1-7 and letters Do, Ti, La, So, Fa, Mi, Re. The notes are arranged in a descending sequence from top to bottom, following the path of the triangle's sides.

Line	Label
12	Do
11	Ti
10	La
9	So
8	Fa
7	Mi
6	Re
5	Do
4	Ti
3	La
2	So
1	Fa
12	Mi
11	Re
10	Do
9	Ti
8	La
7	So
6	Fa
5	Mi
4	Re
3	Do
2	Ti
1	La
12	So
11	Fa
10	Mi
9	Re
8	Do
7	Ti
6	La
5	So
4	Fa
3	Mi
2	Re
1	Do

TIPS VOOR HET STEMMEN

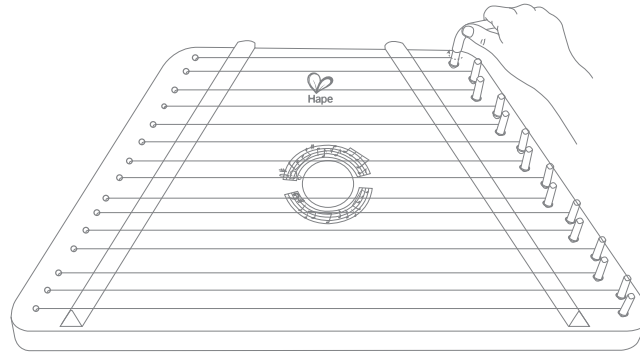

E0323

Net zoals bij een klassieke gitaar zijn de snaren uit nylon gemaakt. Nylon snaren zijn veel veiliger dan metalen snaren. Maar zoals bij elk professioneel instrument kan het noodzakelijk zijn om je harp voor ingebruikname en vervolgens regelmatig voor gebruik te stemmen.

Er zijn vele stemapparaten die je kan gebruiken om je harp te stemmen. Je kan een stempijp, stemvork, piano, elektronisch keyboard of ander muziekinstrument dat reeds juist is gestemd gebruiken. Je kan tevens stemsoftware vanaf je mobiele telefoon downloaden.

Om te stemmen, kies een toonaard die je wilt gebruiken. Laat het geluid van de toonaard vervolgens met het geluid van de langste snaar op de harp overeenstemmen. Eenmaal de eerste snaar is gestemd, pas de andere snaren aan door de toonladder opeenvolgend omhoog te gaan. (do, re, mi, enz.).

Na alle snaren in de juiste toonladder te hebben gestemd, breng een muziekblad in en speel een liedje waarmee je vertrouwd bent (we bevelen "Twinkle, Twinkle, Little Star" aan).

Als het liedje juist klinkt, dan heb je de harp met succes gestemd. Als het liedje niet juist klink of je weet het verschil niet, raden we aan om de harp door een vriend of een muzikexpert (lokale muzikwinkel of muzikleraar) te laten stemmen.

HOE JE BLIJE HARP VAN NIEUWE SNAREN VOORZIEN

Laat het vervangen van snaren altijd door een volwassene uitvoeren. Als je niet goed weet hoe de volgende taken uit te voeren, vraag hulp aan je lokale muziekwinkel of muziekleraar.

Je hebt een buigtang en kniptang nodig.

We bevelen tevens aan om een veiligheidsbril te dragen.



Maak de pinnen los door deze elk vijf volledige omwentelingen te draaien.

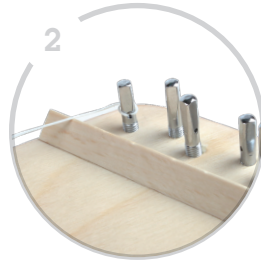

Steek de snaar door het gat in de stempin. Buig de snaar na deze door de stempin te hebben gestoken om de snaar op zijn plaats te houden.

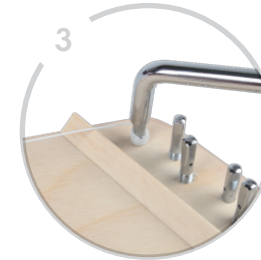

Draai de stempin circa 5 volledige omwentelingen vast. Zorg dat de snaar onder het gat in de stempin is gewikkeld.



Nadat de eerste stempin van draad is voorzien, rijg de snaar door het parallelle gat aan de linkerzijde van de harp en vervolgens opnieuw door het gat direct eronder zodat de draad opnieuw aan de voorkant verschijnt. Voltooi de 2^e rij door de 2^e stempin rechtsboven van draad te voorzien. Ga verder met het rijgen van draad op dezelfde manier voor de andere rijen die vervangen moeten worden. (Opgelet, deze stap is niet nodig op de onderste snaar aangezien deze slechts één stempin en gat heeft).

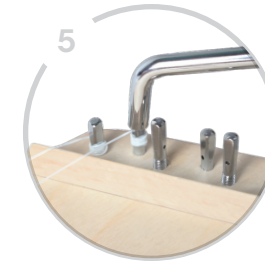
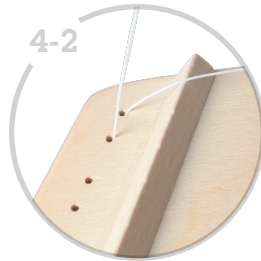

Herhaal stappen 2 en 3 om een andere pin vast te maken.

Gebruik een kniptang om overtollige snaar af te knippen en buig het uiteinde van de snaar vervolgens omlaag om de speler tegen mogelijk letsel te beschermen.

Maak regelmatig gebruik van deze Blije harp tips om je instrument te stemmen.



Blije harp

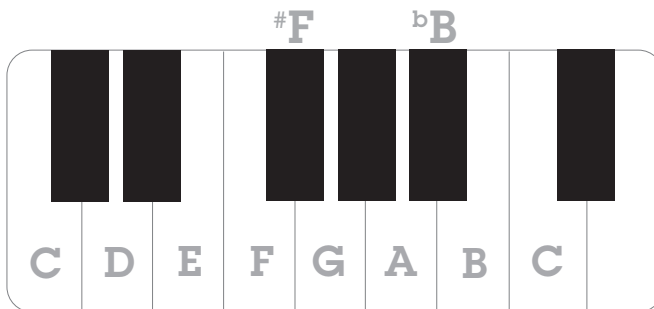

G Do 1	#F Ti 7	i Do F
E La 6	D So 5	7 Ti E
D So 5	C Fa 4	6 La D
C Fa 4	B Mi 3	5 So C
B Mi 3	A Re 2	4 Fa bB
A Re 2	G Do i	3 Mi A
G Do i	#F Ti 7	2 Re G
#F Ti 7	E La 6	i Do F
E La 6	D So 5	7 Ti E
D So 5	C Fa 4	6 La D
C Fa 4	B Mi 3	5 So C
B Mi 3	A Re 2	4 Fa bB
A Re 2	G Do 1	3 Mi A
G Do 1		2 Re G
		1 Do F

So-fa syllabes

Genummerde muzieknotatie

Pitchnaam

"C" TOONAARD

"D" TOONAARD

"E" TOONAARD

"F" TOONAARD

"G" TOONAARD

Do	Re	Mi	Fa	So	La	Ti	5 So C
1	2	3	4	5	6	7	4 Fa bB
C	D	E	F	G	A	B	3 Mi A
D	E	#F	G	A	B	#C	2 Re G
E	#F	#G	A	B	#C	#D	1 Do F
F	G	A	bB	C	D	E	
G	A	B	C	D	E	#F	

OP DE BLIJE HARP SPELEN

Op de Blijde harp spelen is een ideale ouder-kindactiviteit om kinderen kennis te laten maken met de muziekbeginselen en hen zelf muziek te laten maken. De Blijde harp is tevens een uitstekend instrument voor kinderen van alle leeftijden om hun coördinatie en fijne motoriek te ontwikkelen.

Leer je kind hoe te spelen met behulp van deze activiteiten en oefeningen:

- De liedjes die met de Blijde harp zijn meegeleverd verschillen in moeilijkheidsgraad. Kies één of twee makkelijkere liedjes die je kind kent en zing het liedje samen terwijl je de toonladder introduceert.
- Tokkel op de snaren van de Blijde harp, start vanaf de onderste snaar en laat je kind vervolgens hetzelfde doen. Dit is om het verschil tussen de noten aan te leren.
- Start bij de liedjes die je samen hebt gezongen, plaats een muziekblad onder de snaren van de Blijde harp en speel de eerste frase van het liedje. Bijvoorbeeld, als je "Twinkle, Twinkle, Little Star" hebt gezongen, volg de noten op het muziekblad om "Twinkle, Twinkle, Little Star" te spelen. Laat je kind vervolgens hetzelfde doen.
- Speel het volledig liedje tot het einde, leg de nadruk op het tokkelen van de snaar boven elke noot om het liedje te maken en laat je kind vervolgens het volledig liedje spelen.
- Vertel je kind dat het liedje niet vanaf de eerste keer perfect zal klinken, maar dat door te oefenen de Blijde harp van elke kind een echte musicus maakt!

Blije harp

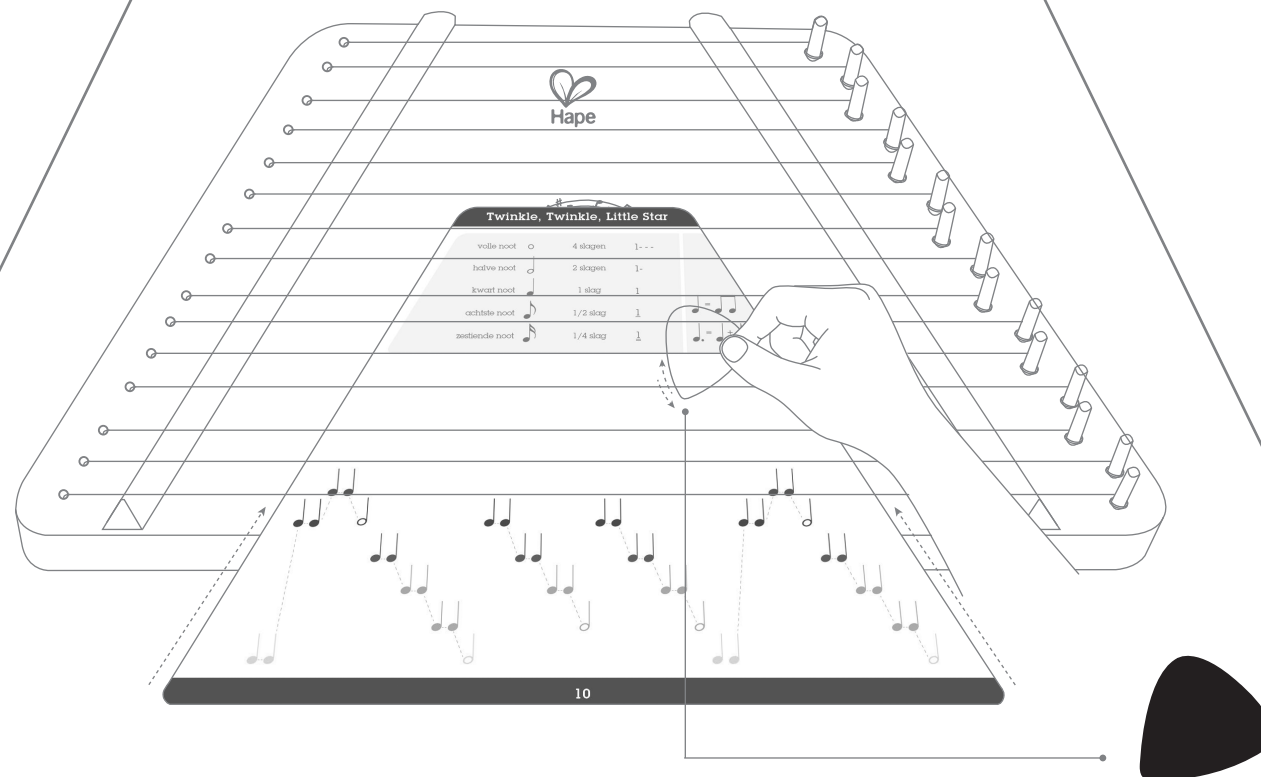

- Selecteer een liedje op een van de acht meegleverde muziekbladen en schuif deze onder de snaren vanaf de bodem naar de bovenkant van de harp.
- Zorg dat het trapeziumvormig muziekblad perfect op het houten platform past. De snaren zijn parallel met de noten op het blad.
- Speel de muziek met het meegeleverd plectrum van links naar rechts overeenkomstig de gekleurde noten. Elke noot staat voor het tokkelen van de overeenkomstige snaar.
 - Speel lichtjes voor een melodieuze toon met je linker- of rechterhand.
- Ga omhoog of omlaag naar de andere snaren om een harmonieus liedje te maken.
 - Oefen het ritme totdat je een perfect liedje hebt gemaakt.
- Speel voor je ouders om je fantastische vaardigheden met hen te delen.

Mary Had a Little Lamb

volle noot	○	4 slagen	1 - - -
halve noot	◐	2 slagen	1 -
kwart noot	◑	1 slag	1
achtste noot	◒	1/2 slag	<u>1</u>
zestiende noot	◓	1/4 slag	<u><u>1</u></u>

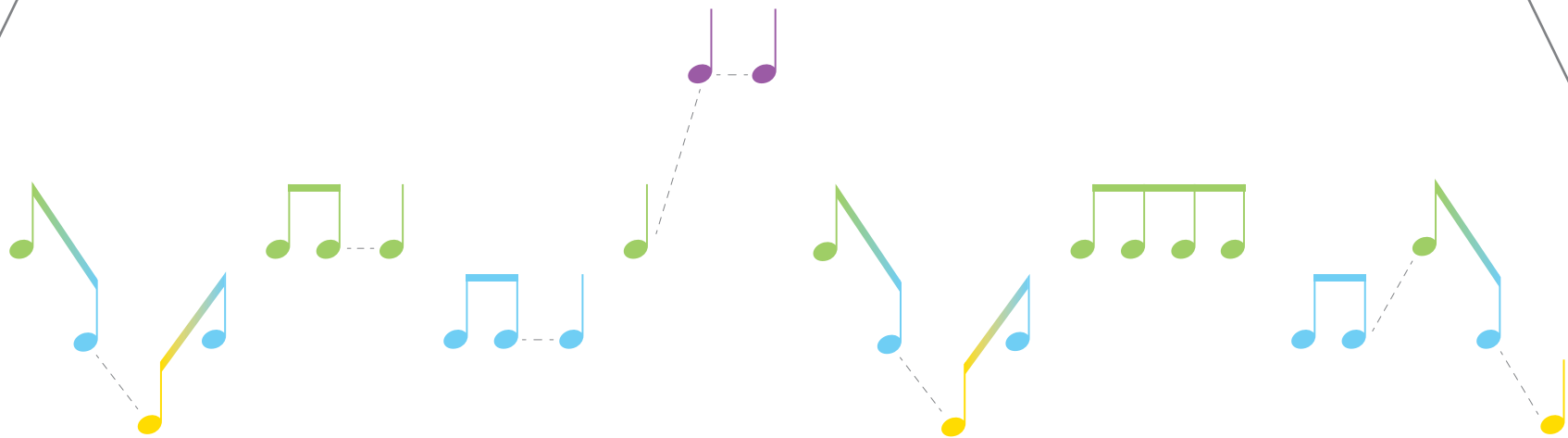

London Bridge Is Falling Down

volle noot	○	4 slagen	1 - - -
halve noot	○	2 slagen	1 -
kwart noot	●	1 slag	1
achtste noot	●	1/2 slag	<u>1</u>
zestiende noot	●	1/4 slag	<u><u>1</u></u>

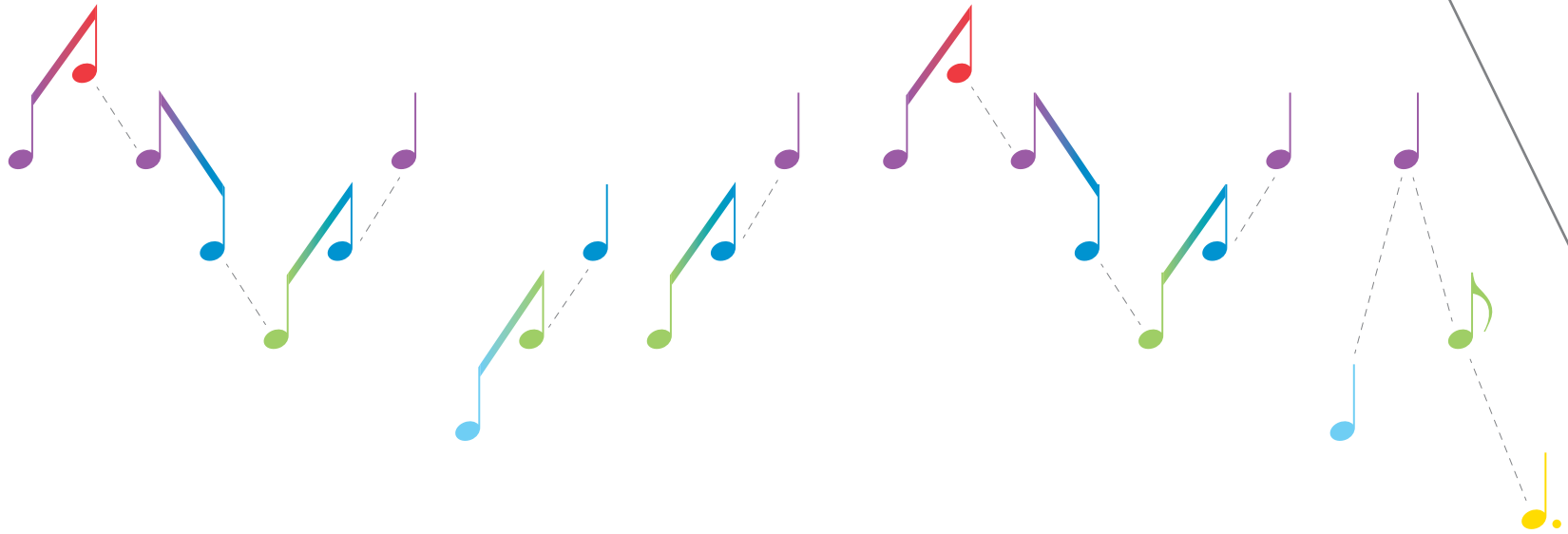
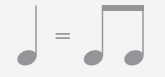

Happy Birthday to You

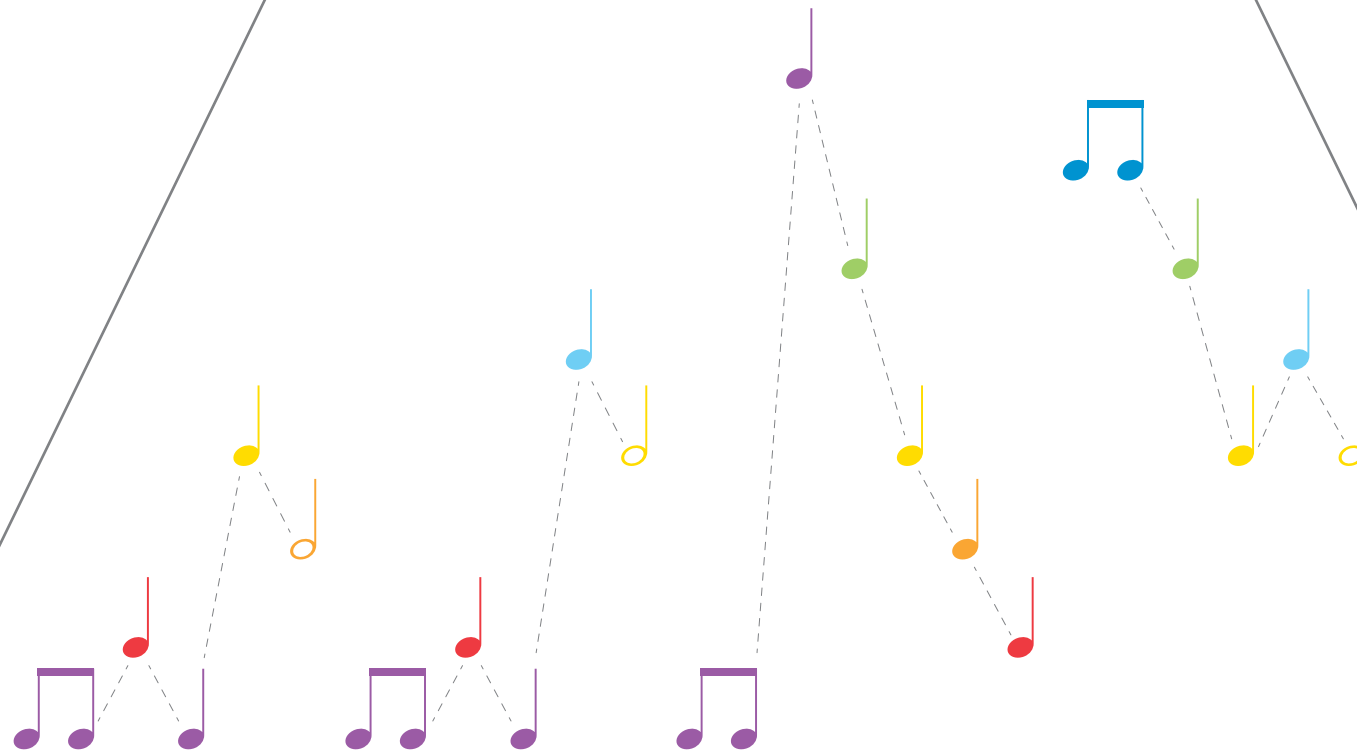

volle noot	○	4 slagen	1 - - -
halve noot	◐	2 slagen	1 -
kwart noot	●	1 slag	1
achtste noot	♪	1/2 slag	<u>1</u>
zestiende noot	♩	1/4 slag	<u>1</u>



Do
Ti
La
So
Fa
Mi
Re
Do
Ti
La
So
Fa
Mi
Re
Do

i
7
6
5
4
3
2
i
7
6
5
4
3
2
i
7
6
5
4
3
2
1

DICAS DE AFINAÇÃO

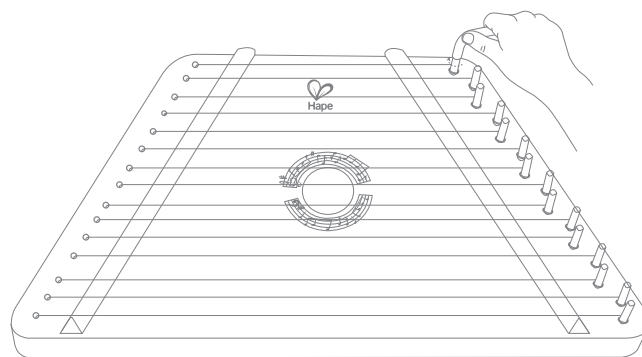

E0323

Tal como a guitarra clássica, as cordas são de nylon. O nylon é muito mais seguro do que as cordas de metal. No entanto, tal como todos os instrumentos profissionais, a sua harpa pode ter de ser afinada após levá-la para casa, e poderá ter de a voltar a afinar periodicamente.

Existem muitos instrumentos de afinação que podem ser usados para sintonizar a sua harpa. Pode usar um afinador, um diapasão, piano, órgão ou qualquer outro instrumento musical que esteja devidamente afinado. Também pode descarregar software de sintonização para o seu telemóvel.

Para sintonizar, escolha uma tecla que queira usar. A seguir, corresponda o som da tecla ao som da corda mais comprida da harpa. Quando tiver a primeira corda afinada, ajuste as outras cordas sequencialmente, subindo na escala (dó, ré, mi, etc.).

Após sintonizar todas as cordas na escala correcta, insira uma pauta musical e toque uma música que conheça (sugerimos "Brilha, brilha lá no céu").

Se a música tiver um som correcto, conseguiu afinar com sucesso a harpa. Se o som não parecer o correcto ou não conseguir reparar na diferença, recomendamos que leve a harpa para ser afinada por um amigo ou profissional (loja de música local ou professor de música) que esteja familiarizado com música.

COMO COLOCAR NOVAS CORDAS NA SUA HARPA FELIZ

A substituição das cordas só deverá ser feita por um adulto. Se não se sentir à vontade para o fazer, peça ajuda na sua loja de música local ou a um professor de música.

Precisa de um alicate e um cortador de arame.
Também recomendamos a utilização de óculos de segurança.

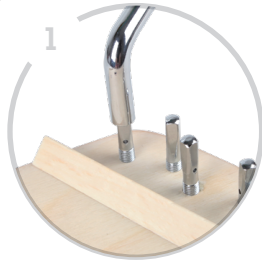

Desaperte as cavilhas cerca de cinco voltas completas cada uma.

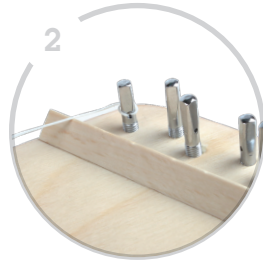

Enrosque a corda através do orifício na cavilha de afinação. Dobre a corda após inseri-la pela cavilha de afinação, para a manter no respectivo lugar.

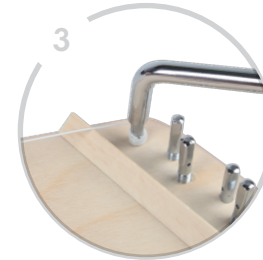

Aperte a cavilha de afinação aproximadamente cinco voltas completas. Certifique-se de que a corda fica enrolada abaixo do orifício da cavilha de afinação.

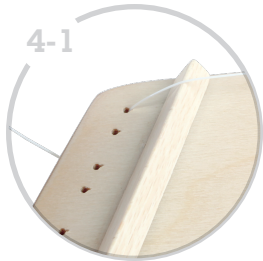

Após enroscar a primeira cavilha de sintonização, enrosque a corda através do orifício paralelo do lado esquerdo da harpa, puxando a corda para cima através do orifício directamente por baixo.

Termine a 2ª fila enroscando a 2ª cavilha de sintonização a partir do topo no lado direito.

Continue a enroscar as filas de cordas do mesmo modo para as outras que precisem de ser substituídas (Tenha em conta que este passo não é necessário na corda inferior, pois só tem uma cavilha de sintonização e um orifício.)

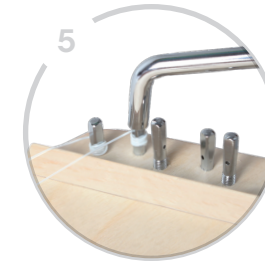
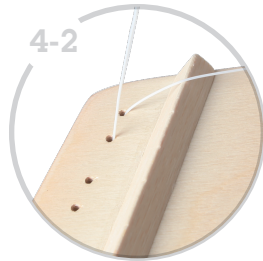

Repita os passos 2 e 3 para apertar outra cavilha.

Use o cortador de arame para retirar a corda em excesso e dobrar cuidadosamente a extremidade da corda para baixo, para proteger os utilizadores da ponta da corda.

Use regularmente as dicas de afinação da Harpa Feliz para afinar com precisão o seu instrumento.

APRENDER A TOCAR A HARPA FELIZ

Tocar a Harpa Feliz é uma actividade entre pais e filhos ideal para introduzir as crianças aos pontos básicos da música e para lhes permitir tocar música sozinhas. Além disso, a Harpa Feliz é uma excelente ferramenta para crianças de todas as idades para desenvolverem a coordenação e capacidades motoras precisas. Ajude a criança a aprender a tocar, usando estas actividades e exercícios:

- As músicas incluídas com a Harpa Feliz têm várias dificuldades. Escolha uma ou duas músicas mais fáceis que a criança conheça e cante as músicas juntos, apresentando a pauta musical.
- Toque as cordas da Harpa Feliz, começando da corda mais em baixo e subindo, e peça à criança para fazer o mesmo. Isto ajuda-as a aprenderem as diferenças entre as notas.
- Comece com as mesmas músicas que cantam juntos, coloque uma pauta musical por baixo das cordas da Harpa Feliz e toque a primeira frase da música. Por exemplo, se cantar "Brilha, brilha lá no céu", siga as notas da pauta musical para tocar "Brilha, brilha lá no céu". A seguir, peça à criança para fazer o mesmo.
- Toque toda a música até ao fim, dando ênfase à ideia de tocar a corda acima de cada nota para criar a música e deixe a criança tocar a música toda.
- Ajude a criança a compreender que, no início, pode não ter um grande som, mas, com um pouco de prática, a Harpa Feliz pode fazer com que qualquer criança pareça um grande músico!

Happy Harp

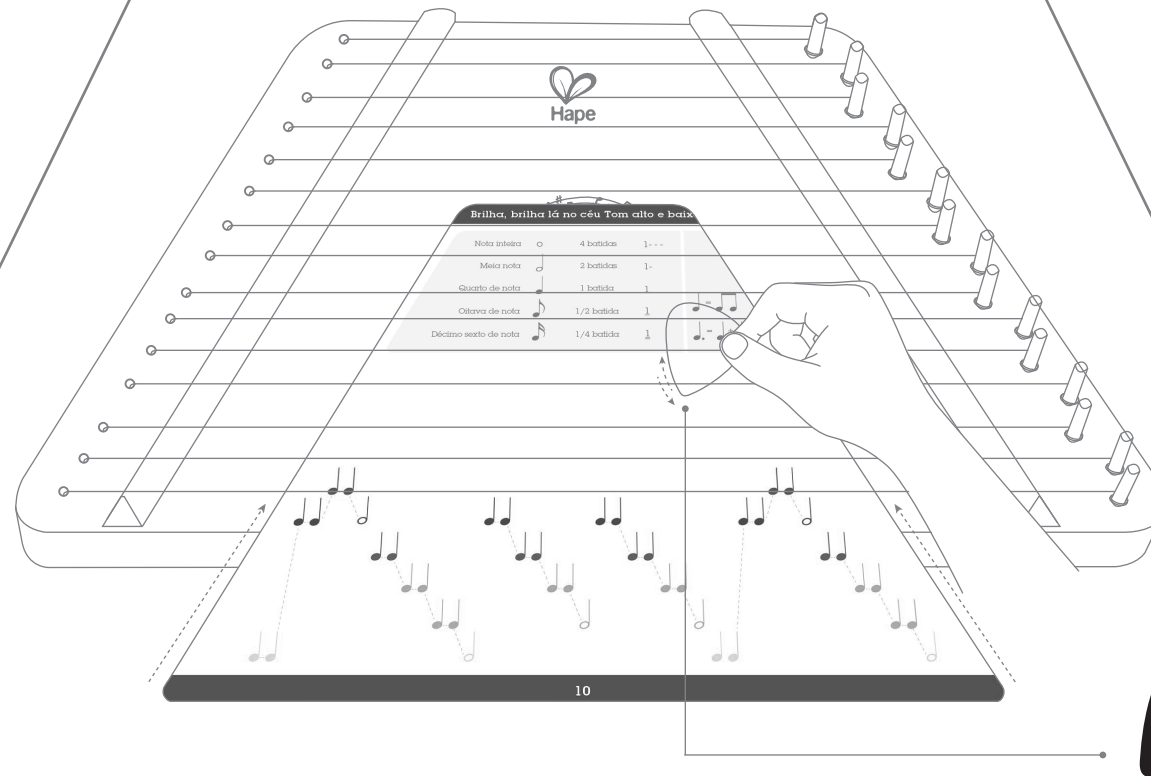

- Escolha uma música entre as oito pautas musicais incluídas e insira-a por baixo das cordas e no topo da harpa.
- Certifique-se de que a pauta musical em forma de trapézio assenta perfeitamente na plataforma de madeira.
As cordas ficarão paralelas às notas na pauta.
- Toque a música com a palheta incluída da esquerda para a direita, de acordo com as notas coloridas.
Cada nota serve para escolher a corda correspondente.
- Toque levemente para um tom melódico, tanto com a mão direita como com a mão esquerda.
 - Suba ou desça às outras cordas para criar uma música harmoniosa.
 - Pratique o ritmo até criar uma música perfeita.
- As crianças devem treinar com os pais para partilharem as suas maravilhosas qualidades.

Maria tinha um carneirinho

Nota inteira	○	4 batidas	1 - - -
Meia nota	◐	2 batidas	1 -
Quarto de nota	◑	1 batida	1
Oitava de nota	◒	1/2 batida	<u>1</u>
Décimo sexto de nota	◓	1/4 batida	<u><u>1</u></u>

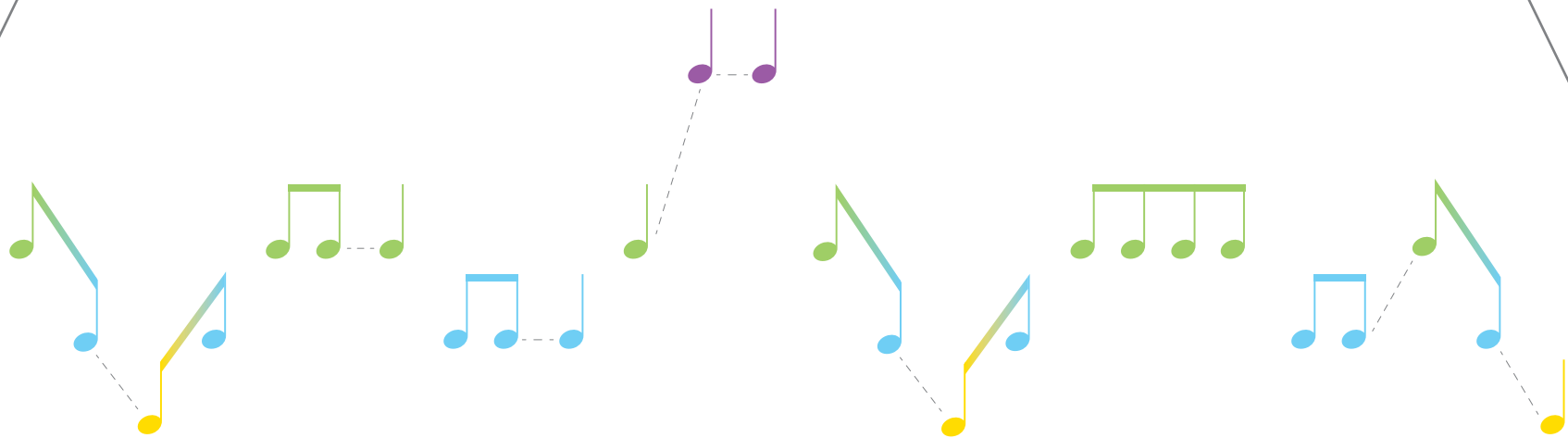

Row, Row, Row Your Boat

Nota inteira	○	4 batidas	1 - - -
Meia nota	○	2 batidas	1 -
Quarto de nota	●	1 batida	1
Oitava de nota	♪	1/2 batida	<u>1</u>
Décimo sexto de nota	♪	1/4 batida	<u><u>1</u></u>

♪ = ♪ ♪

♪. = ♪ + ♪

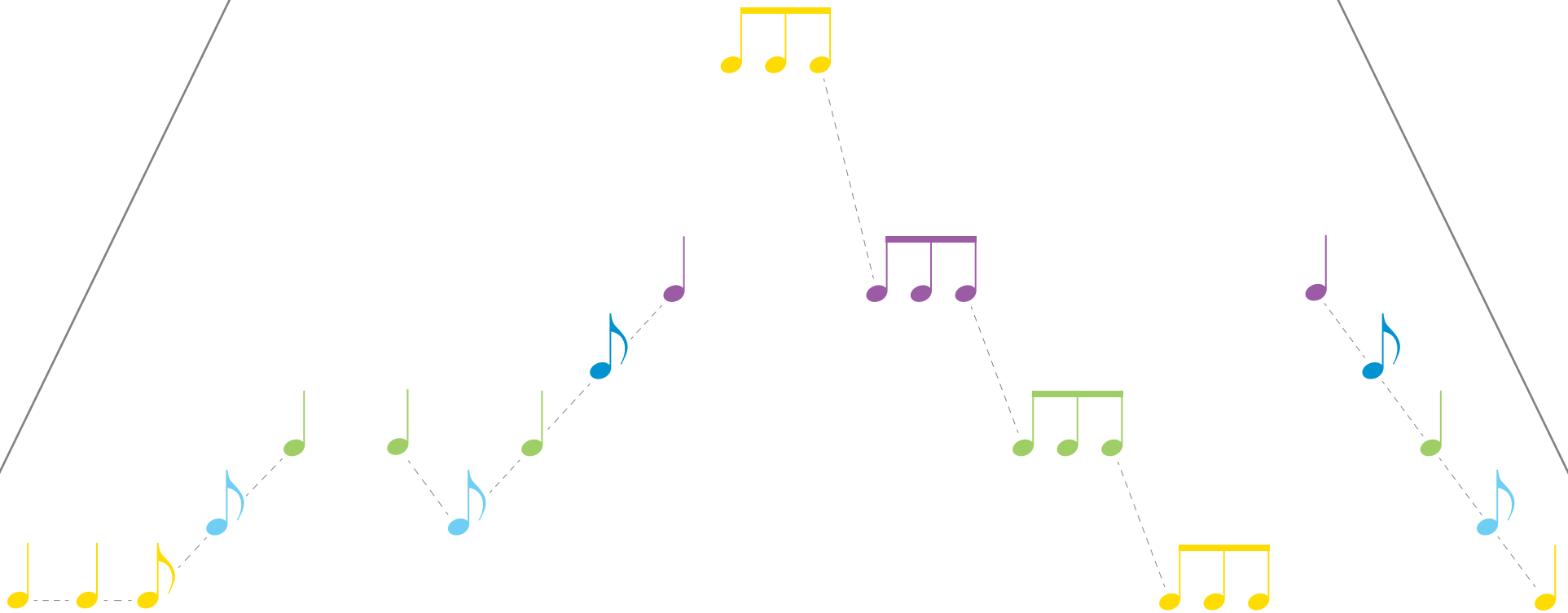

London Bridge Is Falling Down

Nota inteira	○	4 batidas	1 - - -
Meia nota	○	2 batidas	1 -
Quarto de nota	●	1 batida	1
Oitava de nota	♪	1/2 batida	<u>1</u>
Décimo sexto de nota	♪	1/4 batida	<u><u>1</u></u>

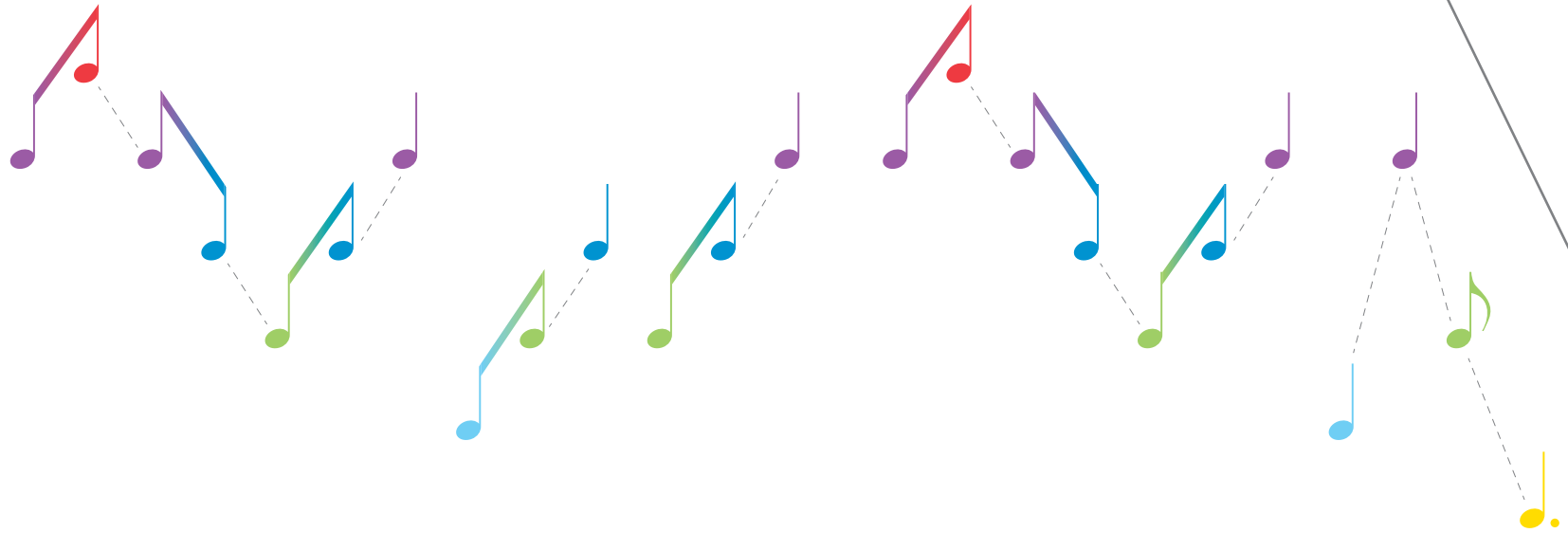

Parabéns a você

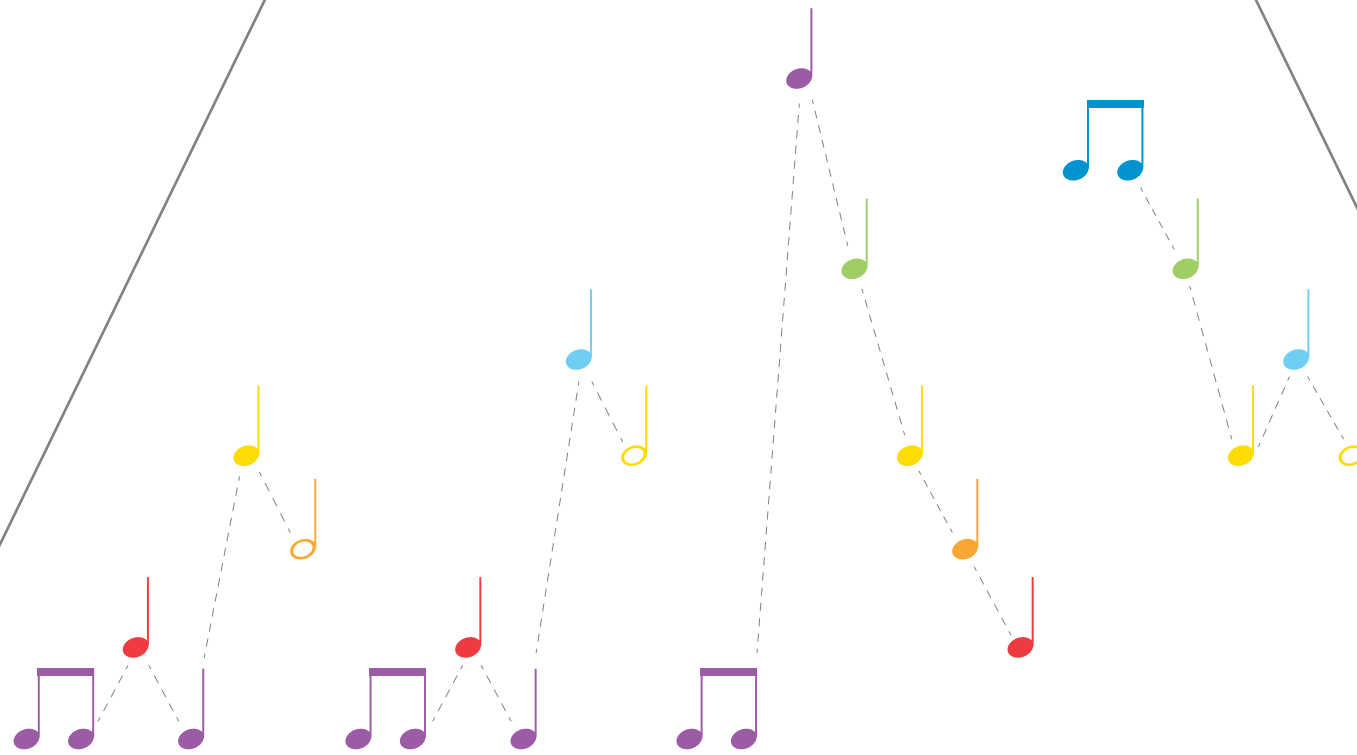

Nota inteira		4 batidas	1 - - -
Meia nota		2 batidas	1 -
Quarto de nota		1 batida	1
Oitava de nota		1/2 batida	<u>1</u>
Décimo sexto de nota		1/4 batida	<u><u>1</u></u>

=

= +

Brilha, brilha lá no céu

Nota inteira	○	4 batidas	1 - - -
Meia nota	♪	2 batidas	1 -
Quarto de nota	♩	1 batida	1
Oitava de nota	♪	1/2 batida	<u>1</u>
Décimo sexto de nota	♫	1/4 batida	<u><u>1</u></u>

